

EATON

MEM

MEM Circuit Protection & Control

Industrial Switch and Fusegear

2003 Catalogue



The World's Most Comprehensive
Range Of Equipment

MEM

EATON

MEM



THE SOURCE OF CIRCUIT PROTECTION SOLUTIONS

As a market-leading manufacturer of circuit protection and control equipment, Eaton MEM's world leading switch and fusegear, circuit breaker and wiring accessory products are distributed across the globe.

Incorporating the latest technological advances, our products are the result of a comprehensive ongoing development programme and comply with the industry's most rigorous quality standards. This all serves to make Eaton MEM an industry benchmark, with unsurpassed quality and performance guaranteed.

This extensive product range, together with our lengthy experience and specialist knowledge serves to make Eaton MEM the only source for your installation needs.

Eaton Corporation is a global \$7.2 billion diversified industrial manufacturer that is a leader in fluid power systems; electrical power quality, distribution and control; automotive engine air management and fuel economy; and intelligent drivetrain systems for fuel economy and safety in trucks. Eaton has 51,000 employees and sells products in more than 50 countries. For more information, visit www.eaton.com.

www.memonline.com

MEM

C O N T E N T S

INDUSTRIAL SWITCH & FUSEGEAR

GLASGOW

- FUSE-SWITCH-DISCONNECTORS
- SWITCH-DISCONNECTORS
- BUSBAR CHAMBER SYSTEM

EXEL 2

- SWITCH-DISCONNECTOR-FUSES
- SWITCH-DISCONNECTORS
- SPSN SWITCH-DISCONNECTOR-FUSE

MEMPROOF

- SWITCH-DISCONNECTORS

MEMLOK

- ON-LOAD CHANGEOVER SWITCHES
- FIREMAN'S SWITCHES
- MAIN EARTHING TERMINAL BARS
- EARTH LEAD ADAPTORS
- TOUCH UP PAINT

EXEL

- DISTRIBUTION FUSEBOARDS

HRC CARTRIDGE FUSELINKS & FUSE UNITS

PARAMOUNT

- HRC CARTRIDGE FUSELINKS
- SEMI-CONDUCTOR FUSES
- FUSE CARRIERS & BASES
- MOULDED HRC FUSE UNITS

PANEL MOUNTING SWITCHGEAR

- FUSED COMBINATION SWITCHES
- LOAD BREAK SWITCHES

SPECIALIST HEAVY DUTY SWITCHGEAR

- IP65 LOCAL SWITCH-DISCONNECTORS, 20-63A
- IP55 LOCAL SWITCH-DISCONNECTORS, 20-63A

EXEL IP

- IP55 & IP65 LOCAL SWITCH-DISCONNECTORS, 20-1250A

SPECIAL DISTRIBUTION & CONTROL EQUIPMENT

SWITCHBOARDS

MEMFORM

- FORM 4 CUBICLE SWITCHBOARDS
- PACKAGED SUBSTATIONS

DEGREES OF PROTECTION – IP

INDEX

NEW PRODUCTS

- 4
- 4
- 10
- 14
- 14
- 16
- 16
- 17
- 18
- 19
- 19
- 19
- 20
- 24
- 33
- 35
- 36
- 38
- 54
- 60
- 61
- 62
- 65
- 66
- 70
- 71
- 72



MEMLOK On-load Changeover Switches, see page 17

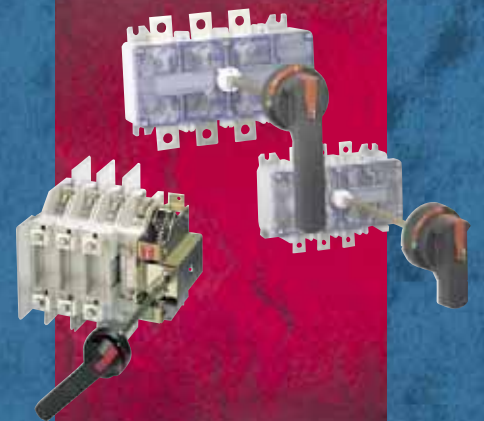

PANEL MOUNTING SWITCHGEAR
Fused Combination Switches, see page 38
Load Break Switches, see page 54



EXEL IP IP55 Local Switch-disconnectors, see page 62



INDUSTRIAL SWITCH AND FUSEGEAR

THE WORLD'S MOST COMPREHENSIVE RANGE OF EQUIPMENT



- Market leading products include...
- Glasgow – fuse-switch-disconnectors & switch-disconnectors, 63A to 800A
- Glasgow busbar chamber system, 100A to 800A
- Exel 2 - switch-disconnector-fuses & switch-disconnectors, 20A to 125A
- Exel HRC distribution fuseboards, 20A to 200A
- SPSN switchfuses up to 100A
- Memlok moulded changeover switches, 20A to 63A
- Memproof enclosed disconnectors, 20A to 63A
- Firemans emergency switches 20A & 32A

From the very start Eaton MEM has earned a worldwide reputation for reliable, high quality switch and fusegear – an area in which we are clear market leaders. Constantly updated and refined to comply with the very latest international standards the range can accommodate the diverse requirements of the contractor, specifier, OEM and distributor alike.

Our market leading switchgear range combined with specialist heavy duty switchgear and special distribution and control equipment means Eaton MEM offers a vast choice, flexible approach and total solution to your installation needs.

GLASGOW FUSE-SWITCH-DISCONNECTORS & SWITCH-DISCONNECTORS

- Comply with BSEN60947-3
- Conditional short circuit rating = 80kA, 415V
- Five frame sizes offer ratings of 63A to 800A
- Excellent AC22A & AC23A (Ue 415V)
- Range of auxiliary equipment
- Page 4

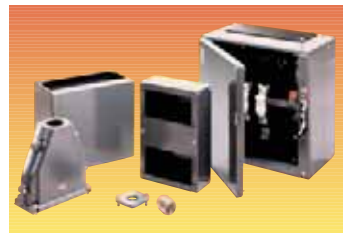

GLASGOW BUSBAR CHAMBER SYSTEM

- Comply with BSEN60439-1
- Conditional short circuit rating = 63kA, 550V
- Five ratings of 100A to 800A
- Lengths of 550mm, 900mm, 1350mm, 1800mm
- Range of ancillary equipment including pedestal sets
- Page 10



EXEL 2 SWITCH-DISCONNECTORS & SWITCH-DISCONNECTOR-FUSES

- Comply with BSEN60947-3
- Conditional short circuit rating = 80kA, 415V
- Five frame sizes offer ratings of 20A to 125A
- Excellent AC22A & AC23A ratings (Ue 415V)
- Suitable for use on AC or DC
- Page 14



EXEL HRC DISTRIBUTION FUSEBOARDS

- Comply with BS5486: Part 11: 1989
- Enclosures available up to IP4X
- Five ratings of 20A to 200A
- Safety carriers available
- Page 20



SPSN SURFACE MOUNTING SWITCHFUSE

- Double pole isolating switch tested to BSEN60947-3
- Conditional short circuit rating = 16kA, 240V
- 80A or 100A fuselink fitted as standard
- 2-63A fuselinks can be fitted
- Fully shrouded fuse carrier
- Safety carriers available
- Page 16





MEMLOK CHANGEOVER SWITCHES

- Moulded enclosures to IP65
- 20A, 25A, 40A, 63A
- Metalclad enclosures to IP54
- 32 to 800A
- Page 17



MEMPROOF ENCLOSED DISCONNECTORS

- For use as an isolating switch in all types of circuits
- Comply with IEC 60947-3
- Four ratings from 20A to 63A
- Available in Double Pole, Triple Pole and Switched Neutral
- Enclosures are IP57 rated
- Page 16



FIREMANS EMERGENCY SWITCHES

- Double pole switches suitable for AC or DC to BSEN60947-3
- Heavy duty cast enclosures to IP55
- Pole operated ring handle automatically locks in the 'OFF' position
- Flush version
- Page 18



INDUSTRIAL SWITCH AND FUSEGEAR

GLASGOW FUSE-SWITCH-DISCONNECTORS AND SWITCH-DISCONNECTORS



RATING TO BSEN60947-3

General Performance Characteristics

NOMINAL UNIT RATING I _e	UTILIZATION CATEGORY AT U _e 415V TO BSEN60947-3	
	SWITCH - DISCONNECTOR AC21A I _e	FUSE-SWITCH - DISCONNECTOR AC22A I _e AC23A I _e
63A	125A	63A 41A
100A	125A	100A 41A
160A	Use 200A	160A 160A
200A	315A	200A 160A
315A	Use 400A	315A 200A
400A	400A	400A 200A
500A	Use 630A	500A 385A
630A	630A	630A 385A
800A	800A	800A 500A

OPERATIONAL PERFORMANCE

In accordance with BSEN60947-3: 1992 'A' categories all ratings have been tested to values specified below:

RATED OPERATIONAL CURRENT I _e	OPERATING CYCLES		TOTAL
	WITHOUT CURRENT	WITH CURRENT	
63 - 100A	8,500	1,500	10,000
160 - 400A	7,000	1,000	8,000
500 - 630A	4,000	1,000	5,000
800A	2,500	500	3,000

LOCKING DEVICES

Facilities are provided for locking off operating handles and securing doors as under:

CURRENT RATING A	LIST NO. LOCKING DEVICE	LIST NO. PADLOCK
Handle locking 63-800A	★	PD1
Door locking 63-400A	6LD	PD1
500-800A	8LD	PD1

* Operating handles of all units can be locked 'ON' or 'OFF' using padlock only.

Non standard hasps on padlock available to order.

All units are supplied with fuselinks or switchlinks fitted. Glasgow fuse-switch-disconnectors and switch-disconnectors are type tested to BSEN60947-3 and meet the constructional requirements for isolation as specified in BSEN60947-3.

Conditional short circuit current rating tests at a value of 80kA rms U_e 415V have been carried out with Eaton MEM HRC fuses fitted. Five frame sizes are available to provide a range from 63A to 800A, with utilization category AC22A and AC23A U_e 415V ratings as specified in table below. Switch-disconnectors fitted with copper links give assigned AC20A U_i 660V and AC21A U_e 415V ratings as specified in table below.

All units have retractable operating handles which drive over-centre mechanisms incorporating powerful operating springs. Opening and closing of the switches is not solely dependent upon these springs. Moving contact assemblies can be removed to facilitate installation or for contact inspection or renewal. Flag "on-off" indication is provided and terminal cover shields prevent contact with live metal.

TPSN indicates triple-pole and switched neutral, the neutral pole making first and breaking last.

Rated Insulation Voltage U_i 660V.

ENCLOSURES

Surface-mounting enclosures comprise heavy gauge steel body plates incorporating cast iron frame members and are rust-protected, with a light grey paint finish. Front access doors, which are detachable, are fitted with dust-excluding gaskets and are interlocked to prevent opening when the switch is 'on'.

The interlock can be defeated by a competent person for maintenance purposes. Operating handles may be locked in both the 'on' and 'off' positions. Castell type interlocks can be supplied to special order. Internal fixing holes allow units to be mounted closely side by side and all models have removable top and bottom end plates. These are pierced for connections, divided into front and rear (fixed) portions to simplify cabling using Eaton MEM split-type cable boxes, and provided with undrilled cover plates.

FUSES

Glasgow units are designed for use with HRC cartridge fuse links to BS88: Part 2. 63A and 100A units employ off-set contact fuse links. Details of suitable types of HRC cartridge fuse links are listed on page 8.

All performance tests have been carried out using Eaton MEM BS88 fuselinks. The exclusive use of Eaton MEM fuselinks will extend the warranty period to 3 years.

MOTOR RATINGS

The motor ratings assigned to TPN switch-disconnector units are utilization category AC23A (frequent operation) to BSEN60947-3, which calls for make and break testing at 10 and 8 times rated current respectively for units having a motor rating up to and including 100 Amps.

Ratings for switch-disconnector-fuses are dependent on suitable HRC fuses being fitted.

AUXILIARY EQUIPMENT

A comprehensive range of extension boxes and spreader boxes is available. A chart to aid selection of suitable equipment together with termination details is provided on pages 8 and 9.

FUSE-SWITCH-DISCONNECTOR

SWITCH-DISCONNECTOR

NOMINAL UNIT RATING Ie	MEM 415V FUSE(S) FITTED	MEM SWITCH LINK(S) FITTED	POLES	STANDARD GLASGOW LIST NO.	NOMINAL RATING Ie AC21A	MEM SWITCH LINK (S) REQUIRED	STANDARD GLASGOW LIST NO.	MOTOR RATING AC23A KW	UE415V HP
63A	63SB4	63MLK	SPSN DP TPN TPSN	61GNC ★ 63GNC 64GC	125A	63MLK	63GNL	22	30
100A	100SD5	100MLK	SPSN DP TPN TPSN	101GNC ★ 103GNC 104GC	125A	100MLK	103GNL	22	30
160A	160SF6	200MLK	SPSN DP TPN TPSN	151GNC ★ 153GNC 154GC	use 200A switch-disconnector				
200A	200SF6	200MLK	SPSN DP TPN TPSN	201GNC ★ 203GNC 204GC	315A	200MLK	203GNL	90	125
315A	315SF7	400MLK	TPN TPSN	303GNC 304GC	use 400A switch-disconnector				
400A	400SF8	400MLK	TPN TPSN	403GNC 404GC	630A	400MLK	403GNL	110	150
500A	500SH9	630MLK	TPN TPSN	503GNC 504GC	use 630A switch-disconnector				
630A	630SH9	630MLK	TPN TPSN	603GNC 604GC	1000A	630MLK	603GNL	225	300
800A	800SH10	800MLK	TPN TPSN	803GNC 804GC	1000A	800MLK	803GNL	300	400

Units are fitted with HRC Fuselinks of maximum rating but will accept fuselinks of a lower rating, refer to the Paramount HRC Fuselinks section on page 24.

SPSN and TPSN indicate switched neutral. Neutral makes first and breaks last.

★ If DP fuse-switch-disconnectors are required, use SPSN and replace the supplied switch link with a compatible fuselink.

DEFINITIONS OF UTILIZATION CATEGORY

- AC20A Connecting and disconnecting under no load condition.
- AC21A Switching of resistive loads including moderate overloads.
- AC22A Switching of mixed resistive and inductive loads including moderate overloads.
- AC23A Switching of motor, or other high inductive loads.

DIMENSIONS

NOMINAL UNIT RATING Ie	POLES	A	B	C	D	E	F	H	J	R
		mm	mm	mm	mm	mm	mm	mm	mm	mm
63A	SPSN, DP	289	199	180	283	203	127	7.9	43	36
	TPN, TPSN	289	275	180	283	203	203	7.9	43	36
100A	SPSN, DP	327	199	180	283	241	127	7.9	43	35
	TPN, TPSN	327	275	180	283	241	203	7.9	43	35
160A, 200A	SPSN, DP	431	280	229	383	340	140	7	45	70
	TPN, TPSN	431	340	229	383	340	200	7	45	70
315A, 400A	TPN, TPSN	501	467	291	545	385	375	10	58	46
500A, 630A, 800A	TPN, TPSN	596	680	381	715	440	550	14	78	65

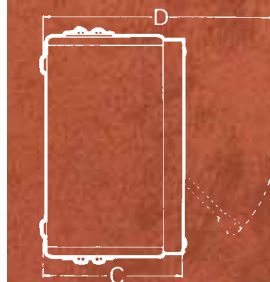
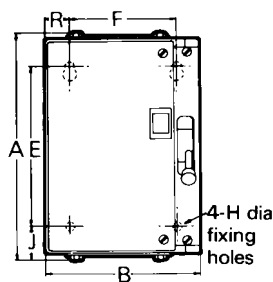

Units have retractable handles. 'D' dimension indicates fully extended operating position.

MEM

INDUSTRIAL SWITCH AND FUSE GEAR GLASGOW AUXILIARY EQUIPMENT



LIST NO.	A mm	B mm	C mm
1PCB	148	133	113
2PCB	148	209	113
3PCB	148	259	132
4PCB	302	347	184
5PCB	213	515	187
6PCB	213	515	327

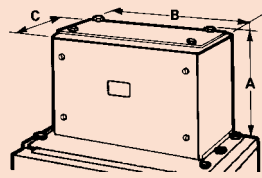

CABLE EXTENSION BOXES

Fabricated sheet steel boxes for fitting to Glasgow switch units to provide additional space for spreading multi-core PVC insulated cables with solid aluminium conductors and for some larger cables with stranded copper conductors.

For 1-3PCB, a plain flame retardant plywood plate is provided for fitting between the box and switch unit, the steel endplate supplied fitted to the switch unit being used on the box's cable entry side.

For 4PCB, a plain steel plate is provided for cable entry on box. The switch enclosure has 8mm thick insulated endplates fitted both ends.

For 5-6PCB, a 10mm thick insulated plate is provided for cable entry on box. The switch enclosure has 10mm thick insulated endplates fitted both ends, 5PCB includes a flame-retardant plywood packer for fitting between PCB and switch unit's endplate to provide lid flange clearance.

LIST NO.	A mm	B mm	C mm	E mm	F mm	FIXING BOLTS	
						NO.	TYPE
Straight entry							
50 CSB	83	232	170	67	171	4	M6
60 CSB	108	283	260	89	216	4	5/16 Whit.
70 CSB	133	384	322	114	318	4	5/16 Whit.
90 CSB	133	530	450	114	457	4	3/8 Whit.
45° Angled entry							
50 CSBA	83	232	250	67	171	4	M6
60 CSBA	108	283	310	89	216	4	5/16 Whit.
70 CSBA	133	384	390	114	318	4	5/16 Whit.
90 CSBA	133	530	510	114	457	4	3/8 Whit.

SPREADER BOXES

Cast metal split pattern, supplied with fixing bolts and plain bushes. Two types are available, suitable for straight or angled entry. They permit conductor spreading of larger PVC cables and fit directly on to Glasgow fuse-switch-disconnectors and switch-disconnectors.

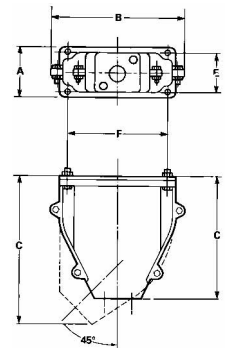

LIST NO.				
405 APL	for fitting	BW40	to	50 CSB(A)
406 APL		BW40		60 CSB(A)
407 APL		BW40		70 CSB(A)
505 APL		BW50		50 CSB(A)
506 APL		BW50		60 CSB(A)
507 APL		BW50		70 CSB(A)
509 APL		BW50		90 CSB(A)
637 APL		BW63		70 CSB(A)
639 APL		BW63		90 CSB(A)
757 APL		BW75		70 CSB(A)
759 APL		BW75		90 CSB(A)

ADAPTOR PLATES

Available for fitting to spreader boxes, tapped to receive Type B compression glands to BS6121: Part 1. Supplied complete with fixing bolts.

Recommendations for suitable glands can be provided if required.

GLASGOW SPARES

Standard spares packs available via the sales office. Other spares are available on request.

DESCRIPTION NOMINAL UNIT RATING I_e	LIST NO.	DESCRIPTION NOMINAL UNIT RATING I_e	LIST NO.
Moving contact fuse carrier; 1 per pole		Fixed contact base complete; 1 per pole	
63A	EBK110SP	63...100A	102GCEBSP
100A	0BK103SP	160...200A	202GCEBSP
160...200A	EBK105SP	315...400A (2 per pole)	402GCEBSP
315...400A	EBK113SP		

INDUSTRIAL SWITCH AND FUSEGEAR

GLASGOW SELECTION INFORMATION

All units are supplied fitted with fuselinks or switch links.

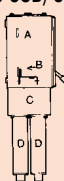
NOMINAL UNIT RATING, I _e	POLES	FUSE-SWITCH-DISCONNECTOR LIST NO.	SWITCH-DISCONNECTOR LIST NO.	EXTENSION BOXES FOR PVC COPPER OR ALUMINIUM CABLES	SPREADER BOXES (CSB - STRAIGHT) (CSBA - ANGLED)	SUITABLE MEM FUSELINKS
63A	SPSN	61 GNC	-	1PCB Not required for copper cables or al. below 35mm ²	-	SB3 and SB4
	DP	★	-		-	
	TPN	63 GNC	63GNL (125A, AC21)	2PCB Not required for copper cables or al. below 35mm ²	or 50 CSB, CSBA	
	TPSN	64 GC	-		-	
100A	SPSN	101 GNC	-	1PCB Not required for copper cables or al. below 50mm ²	-	SB3 SB4 S0 SD5
	DP	★	-		-	
	TPN	103 GNC	103 GNL (125A, AC21)	2PCB Not required for copper cables or al. below 50mm ²	or 50 CSB, CSBA	
	TPSN	104 GC	-		-	
160A	SPSN	151 GNC	} 160A switch links are not available - use 203 GNL	2PCB Not required for copper cables	or 50 CSB, CSBA	SF3 to SF6
	DP	★			-	
	TPN	153 GNC		3PCB Not required for copper cables	or 60 CSB, CSBA	
	TPSN	154 GC			-	
200A	SPSN	201 GNC	-	2 PCB	or 50 CSB, CSBA	SF3 to SF6
	DP	★	-		2 PCB	
	TPN	203 GNC	203 GNL (315A, AC21)	3 PCB	or 60 CSB, CSBA	
	TPSN	204 GC	-		3 PCB	
315A	TPN	303 GNC	} 315A switch links are not available - use 403 GNL	4 PCB	or 70 CSB, CSBA	SF3 to SF7
	TPSN	304 GC			-	
400A	TPN	403 GNC	403 GNL (630A, AC21)	4 PCB	or 70 CSB, CSBA	SF3 to SF8
	TPSN	404 GC	-		4 PCB	
500A	TPN	503 GNC	} 500A switch links are not available - use 603 GNL	5 PCB For parallel cables use: 6 PCB + 802 GCC + 2 x 90 CSB, CSBA	or 90 CSB, CSBA	SH8 and SH9
	TPSN	504 GC				
630A	TPN	603 GNC	603 GNL (1000A, AC21)	PARALLEL CABLE CONNECTION A = 803GNC B = 802GCC C = 6PCB D = 90CSB/A		SH8 to SH10
800A	TPSN	604 GC	-			
	TPN	803 GNC	803 GNL (1000A, AC21)	-	-	-
TPSN	804 GC	-	-	-	-	-

★ If DP fuse-switch-disconnectors are required, use SPSN and replace the supplied switch link with a compatible fuselink.

802 GCC is a four-phase set containing 8 copper connectors, fixings and M16 cable studs.

PCB extension boxes are empty.

Recommendations for compression glands in compliance with BS6121:Part 1				COPPER SWITCH LINKS	COPPER SOCKETS TYPICAL CRIMPING	SOLID AL. SOCKETS TYPICAL CRIMPING	STUD SIZE
COMPRESSION GLANDS FOR PVC SWA STRANDED: CABLE mm ²	2-CORE	4-CORE	ADAPTORS FOR GLANDS TO FIT SPREADER BOXES				
16 25 35	BW20 BW25 BW25	BW25 BW32 BW32	★★ ★★ ★★	63 MLK	Not required Surface mounting unit has tunnel-type terminals (50mm ²)	Swage and fit brass sleeve for cables up to 95mm ²	Tunnel Terminal
25 35 50	BW25 BW25 BW32	BW32 BW32 BW40	★★ ★★ ★★ 405 APL	100 MLK	Not required Surface mounting unit has tunnel-type terminals (50mm ²)	Swage and fit brass sleeve for cables up to 95mm ²	Tunnel Terminal
50 70 95	BW32 BW32 BW40	BW40 BW40 BW50	★★ 405 APL ★★ 405 APL ★★ 405 APL 505 APL	200 MLK	ERMA 41189 (95mm ²)	AWCO 2 SLM 95	M10
50 70 95	BW32 BW32 BW40	BW40 BW40 BW50	★★ 406 APL ★★ 406 APL ★★ 406 APL 506 APL				
70 95 120	BW32 BW40 BW40	BW40 BW50 BW50	★★ 405 APL ★★ 405 APL ★★ 405 APL 505 APL	200 MLK	ERMA 41209 (150mm ²)	AWCO 2 SLM 95	M10
70 95 120 150	BW32 BW40 BW40 BW50	BW40 BW50 BW50 BW50	★★ 406 APL ★★ 406 APL ★★ 406 APL 506 APL				
150 185 240 300	- - - -	BW50 BW63 BW63 BW75	507 APL 637 APL 637 APL 757 APL	400 MLK 400 MLK	ERMA 41735 (300mm ²) ERMA 41735 (300mm ²)	AWCO 4 SLM 300 AWCO 4 SLM 300	M14 M14
240 300 400 2/150 2/185 2/240 2/300	- - - - - - -	BW63 BW75 BW75 BW50 BW63 BW63 BW75	639 APL 759 APL 759 APL 2 x 509 APL 2 x 639 APL 2 x 639 APL 2 x 759 APL	630 MLK 630 MLK 800 MLK	Each copper terminal plate has 1-M16 x 50mm bolt, nut and washers for single hole sockets. 4-M10 tapped holes are also provided for 4 hole sockets or solid copper.		

★★ Sufficient spreading space in switch-disconnector units to mount 'B' gland on to enclosure.

N.B. The details relating to sockets and glands refer to the maximum size of cable for each unit. For details of glands and sockets for smaller cables please refer to gland/socket manufacturer's data.



INDUSTRIAL SWITCH AND FUSEGEAR GLASGOW BUSBAR CHAMBER SYSTEM

The Eaton MEM busbar chamber system is designed to provide either compact, wall-mounting installations or - by using optional pedestal sets - easily assembled switchboards.

Every facility is provided to enable Eaton MEM switchgear and distribution gear to be mounted easily and economically to busbar chambers which can be applied either to a suitable load-bearing vertical surface; or, by means of a pedestal set, affixed to a vertical surface which need not be load-bearing.

BUSBAR CHAMBERS

These are produced in 100, 200, 400, 630 and 800 Amp. ratings and in four nominal lengths (see illustration on page 11). 100, 200 and 400 Amp units are available in all four sizes; 630 and 800 Amp ratings are offered in the three longest units only.

All units in the range share the same height and depth dimensions. Similarly the twin busbars are located in precisely the same positions throughout the range and vary in size only in their front-to-back dimensions according to rating.

Detachable end plates enable all units to be extended by coupling to a second busbar chamber using extension sets. Both top and bottom plates are also readily detachable so that marking out and machining can be carried out conveniently on a bench to accommodate Eaton MEM switchgear either above or below the chamber. Complete mounting kits, including templates, are available for mounting all Exel and Glasgow switchgear.

Eaton MEM busbar chambers are fabricated from rust-protected sheet steel with a light grey paint finish. They have been type tested to BSEN60439-1 with a rated conditional short circuit current rating of 63kA at Ue 550V and a rated short-time withstand current Icw 20 times nominal rated current for one second. They are designed for use in factory-built assemblies to BSEN60439-1.

All chambers are subjected to an on-line dielectric test unit which checks earth continuity and provides a high voltage test between poles; and from poles to earth.

Rated insulation voltage 660V.

PEDESTAL AND BACK-PLATE SETS

Pedestal and back-plate sets are available to accommodate 1800, 1350 and 900mm nominal length Eaton MEM busbar chambers in all ratings. These sets enable complete industrial switchboards to be built up easily and at competitive cost to produce a ready-painted unit of pleasing appearance.

It is recommended that such switchboards are secured against a wall although this need not be a load-bearing structure. Switchgear of 315A and above must be mounted on the underside of the BBC and fastened to the pedestal backplate. Each set comprises two pedestal sideplates and feet plus a pedestal backplate, all ready drilled; together with all necessary fastenings and spacers for floor-mounting bolts. Components are of rust-protected sheet steel with light grey paint finish.

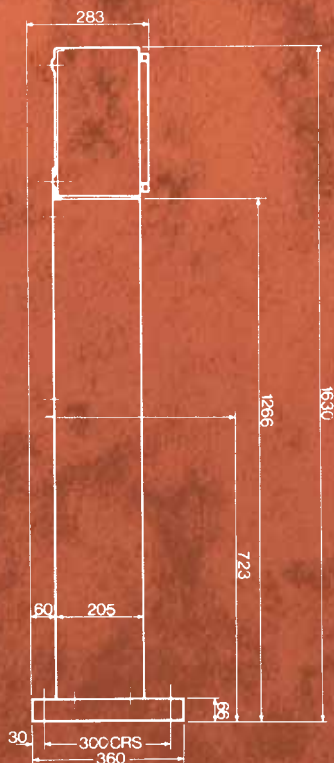
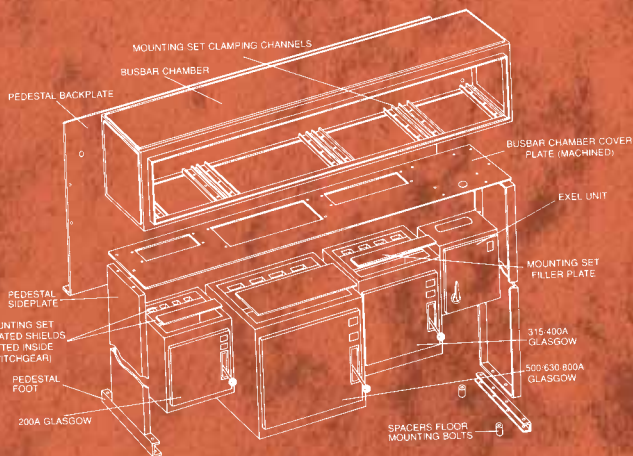

NOMINAL LENGTH OF BUSBAR CHAMBER	PEDESTAL SET LIST NO.
900mm	31 BBPU
1350mm	41 BBPU
1800mm	61 BBPU

NOMINAL UNIT RATING	LIST NO. ACCORDING TO NOMINAL LENGTH, mm			
	550	900	1350	1800
Ie				
100A	142 BBC	143 BBC	144 BBC	146 BBC
200A	242 BBC	243 BBC	244 BBC	246 BBC
400A	442 BBC	443 BBC	444 BBC	446 BBC
630A		643 BBC	644 BBC	646 BBC
800A		843 BBC	844 BBC	846 BBC

NOMINAL LENGTH	A	B	C	D	E	F	G
mm	mm	mm	mm	mm	mm	mm	mm
1800	1812	364	222	280	1724	862	6
1350	1362	364	222	280	1274	-	4
900	912	364	222	280	824	-	4
550	562	364	222	280	474	-	4

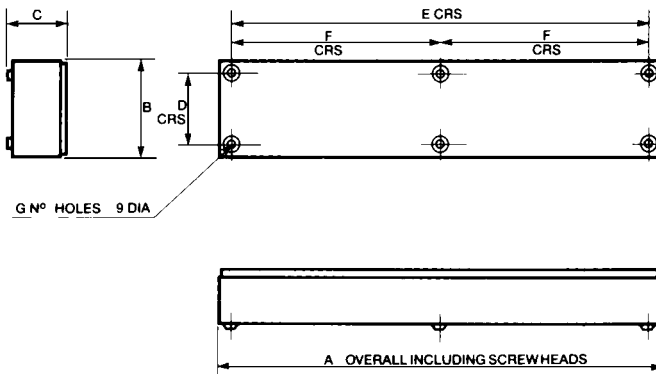

Nominal length chamber 1800mm

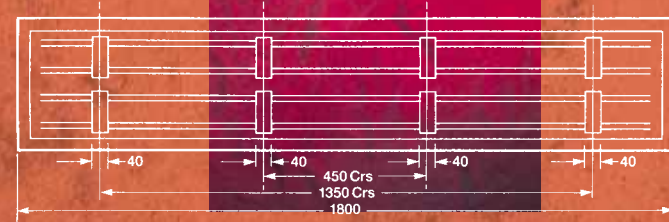

Nominal length chamber 1350mm

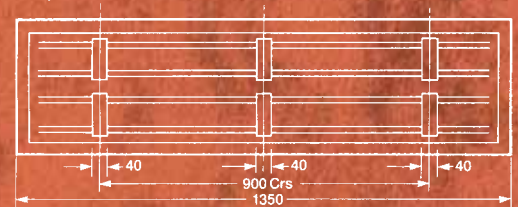

Nominal length chamber 550mm

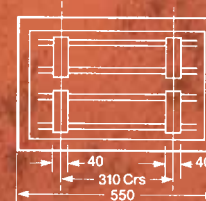

Nominal length chamber 900mm

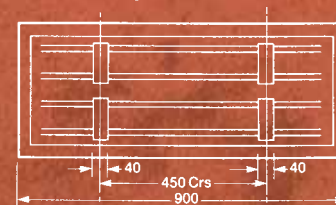

INDUSTRIAL SWITCH AND FUSE GEAR GLASGOW BUSBAR CHAMBER ANCILLARY ITEMS



BUSBAR CHAMBER EXTENSION SETS

Each unit can be coupled to any other Eaton MEM chamber in the range of the same rating by removing adjacent end plates and using the appropriate busbar chamber extension set.

These comprise a set of four copper links complete with all necessary clamps, washers and fasteners plus fitting instructions.

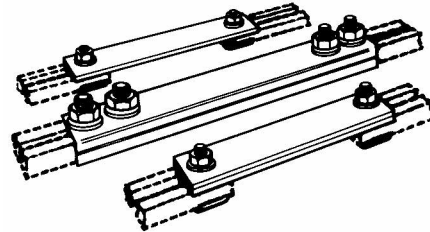

NOMINAL RATING I _e	LIST NO.
100A	21 BBL
200A	21 BBL
400A	41 BBL
630A	81 BBL
800A	81 BBL

BUSBAR SUPPORTS

These porcelain supports are suitable for use with flat busbars only and not with Eaton MEM multiple type bars.

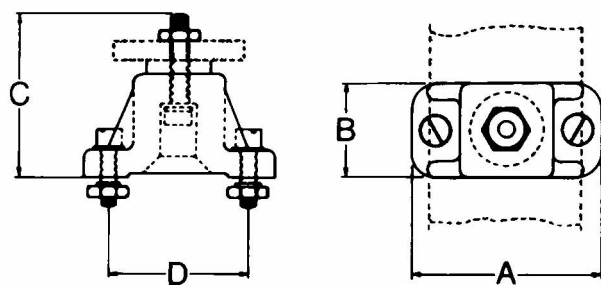

LIST NO.	DIMENSIONS				BUSBAR FIXING BOLT	SUITABLE BUSBAR SECTION mm
	A mm	B mm	C mm	D mm		
10 BM	73	35	60	54	1/4" Whit	32 x 6.4
10 BMD	73	35	79	54	3/8" Whit	51 x 6.4
10 BML	95	51	79	64	3/8" Whit	Larger busbars

N.B. The Glasgow units shown above are drawn to scale. This illustration is intended for use as a guide when planning installations.

CONNECTION SETS FOR GLASGOW FUSE-SWITCH-DISCONNECTORS & SWITCH-DISCONNECTORS

Cable clamps covering all ratings are available as detailed opposite for switchgear up to 200A. For connecting Glasgow units of 160A and above, solid copper connection sets are recommended as cost effective and convenient. These comprise pre-formed, insulated links in 4-pole sets supplied with all necessary clamps and fasteners.

The appropriate switchgear mounting set (41, 51 or 61 BBMS), as detailed below, must be used with connection sets for 160-800A Glasgow units.

NOMINAL RATING I _e	CONNECTION SET LIST NO.
160A, 200A	200 FSCS
315A, 400A	400 FSCS
500A, 630A, 800A	800 FSCS

BUSBAR CABLE CLAMPS AND SOCKETS

Incoming main cable clamps or sockets are not supplied due to the wide range which would be necessary to meet all requirements.

Busbar cable clamps comprise plated brass U-clamps and steel slides with all bolts and washers. They are suitable for the connection of small solid or stranded copper conductors and also aluminium conductors using a barrier grease. Busbar cable sockets are plated brass castings complete with clamps and fixings, suitable for the termination of either copper or aluminium conductors. Both clamps and sockets allow for clamping on the Eaton MEM busbars without drilling.

For cabling direct on to busbars of 630-800A rating a special cable extension is required which can be made to special order.

NOMINAL RATING I _e	BORE DIA. mm	CAPACITY mm ²	LIST NO. 100-200A BUSBARS	LIST NO. 400-800A BUSBARS
U-Clamps				
20A-63A	-	25	2 BBCL	4 BBCL
63A-100A	-	70	3 BBCL	5 BBCL
100A-200A	-	120	6 BBCL	6 BBCL
Sockets				
100A-200A	16.7	150	62 BBSK	62 BBSK
200A-315A	19.0	185	-	72 BBSK
315A-400A	22.5	240	-	82 BBSK

SWITCHGEAR MOUNTING SETS

Available for all ratings of Exel switch-disconnectors/switch-disconnector fuses and Glasgow fuse-switch disconnectors and switch-disconnectors enabling these units to be mounted simply and efficiently either above or below the busbar chamber.

Each mounting set comprises a template with instructions for machining the top/bottom plate of the busbar chamber; clamping channels, ready pierced for fasteners; all necessary fastenings; and -for Glasgow units - insulated shields and switch filler plates where appropriate.

	NOMINAL RATING I _e	MOUNTING SET LIST NO.
Exel Switch-disconnector-fuses/	20A, 32A	11 BBMS
Switch-disconnectors	63A, 100A, 125A	21 BBMS
Glasgow Fuse-switch-disconnectors/	63A, 100A	31 BBMS
Switch-disconnectors	160A, 200A	41 BBMS
	315A, 400A	51 BBMS
	500A, 630A, 800A	61 BBMS

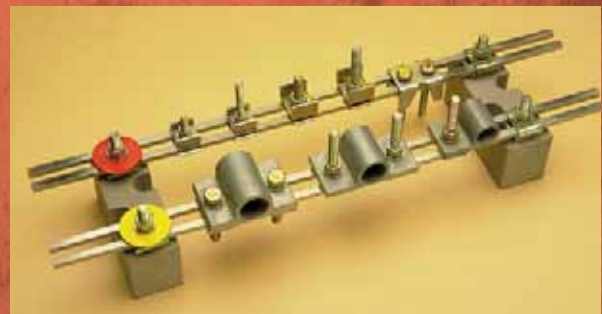

INDUSTRIAL SWITCH AND FUSE GEAR

EXEL 2 SWITCH-DISCONNECTOR-FUSES AND SWITCH-DISCONNECTORS



Exel 2 switch-disconnectors and switch-disconnector-fuses are type tested to BSEN60947-3 and meet the constructional requirements for isolation as specified in BSEN60947-3.

Switches are of the quick make and break type, suitable for use on AC or DC. Units have removable moving contact assemblies to facilitate wiring.

Exel 2 surface-mounting enclosures are fabricated from rust-protected sheet steel with a light grey paint finish with removable top and bottom endplates incorporating knockouts (blank endplates available) and gasketed doors giving IP41 protection. Chromium-plated front operated handles, with "ON (I) OFF (O)" indication, and internal fixing enabling units to be mounted closely side by side. Interiors comprise porcelain bases fitted with non-ferrous conducting components.

FUSES & FUSE CARRIERS

HRC fuse carriers are designed for offset contact fuse links to BS 88: Part 2. Eaton MEM HRC fuse links fitted to switch-disconnector-fuses are suitable on systems up to 415V AC. Eaton MEM fuses used in these products are also suitable for 250V DC systems. All performance tests have been carried out using Eaton MEM BS88 fuselinks. **The exclusive use of Eaton MEM fuselinks will extend the warranty period to 3 years.**

Units are fitted with HRC Fuselinks of maximum rating but will accept fuselinks of a lower rating, refer to the Paramount HRC Fuselinks section on page 24.

HRC pattern switchfuses are fitted with type SCH carriers (20A, 32A, 63A-moulded; 100A, 125A-porcelain). 100A units fitted with moulded carrier type 10SCH can be supplied to special order.

MOTOR RATINGS

The motor ratings assigned to TPN switch-disconnector units are utilization category AC23A (frequent operation) to BSEN60947-3, which calls for make and break testing at 10 and 8 times rated current respectively for units having a motor rating up to and including 100 Amps.

Ratings for switch-disconnector-fuses are dependent on suitable HRC fuses being fitted.

CABLE SIZE

Maximum cable sizes are: 20A-6mm², 32A-10mm², 63A-35mm², 100/125A-70mm².

TYPE TEST COMPLIANCE WITH STANDARDS

This range has been satisfactorily type-tested in accordance with BSEN60947-3 WITH MEM HRC fuselinks fitted.

OPERATIONAL PERFORMANCE

In accordance with BSEN60947-3 all ratings have been tested to values specified below:

OPERATING CYCLES WITHOUT CURRENT	8500
OPERATING CYCLES AT RATED CURRENT	1500
TOTAL	10000

PERFORMANCE VALUES

UNIT	SHORT TIME WITHSTAND CURRENT (R.M.S. AMPS FOR 1 SECOND)	SHORT CIRCUIT MAKING CAPACITY (PEAK AMPS AT 415V AC)	RATED FUSED SHORT-CIRCUIT (PROSPECTIVE R.M.S. AMPS AT 415V AC)
20A	640A	2.96 kA	80 kA
32A	960A	5.12 kA	80 kA
63A	2000A	6.62 kA	80 kA
100/125A	3750A	8.42 kA	80 kA

LOCKING FACILITIES

All units are supplied with operating handles that provide lock-on, lock-off facilities, using padlock PD4. Door locking facilities, using padlock PD1, are available for fitment on site.

NOMINAL UNIT RATING I _e	DOOR LOCKING DEVICE	PADLOCK
20A/32A	4 LD	PD1
63A/100A/125A	5 LD	

NOMINAL RATING I _e	UTILIZATION CATEGORY AT U _e 415V TO BSEN60947-3		250V DC RATING TO BS5419 DC23	POLES	SWITCH-DISCONNECTOR-FUSE-HRC LIST NO.	MEM HRC FUSES FITTED	SWITCH-DISCONNECTOR LIST NO.	BLANK ENDPLATE
	AC22A	AC23A						
20A	20A	-	20A#	SPSN	15KXSC2F*	20SA2	-	EP 842
	20A	-	20A#	DP	15KXDC2F	20SA2	15AXD2	EP 842
	20A	11A	-	TPN	15KXTNC2F	20SA2	15AXTN2	EP 842
32A	32A	-	32A	SPSN	30KXSC2F	32SB3	-	EP 842
	32A	-	32A	DP	30KXDC2F	32SB3	30AXD2	EP 842
	32A	22A	-	TPN	30KXTNC2F	32SB3	30AXTN2	EP 842
63A	63A	-	63A	SPSN	60KXSC2F	63SB4	-	EP 539
	63A	-	63A	DP	60KXDC2F	63SB4	60AXD2	EP 539
	63A	39A	-	TPN	60KXTNC2F	63SB4	60AXTN2	EP 539
100A	100A	-	100A	SPSN	100KXSC2F	100SD5†	-	EP 539
	100A	-	100A	DP	100KXDC2F	100SD5†	100AXD2	EP 539
	100A	52A	-	TPN	100KXTNC2F	100SD5†	100AXTN2	EP 539
125A	125A	52A	-	TPN	125KXTNC2F	125SD6†	125AXTN2	EP 539

SPSN indicates switched neutral. †These units have dual fixings to accept SB3, SB4 and S0 fuselinks. 2x M5 screws required #20A units are DC22. *Also available in red paint finish - **List No. 15KXSC2FRED.**

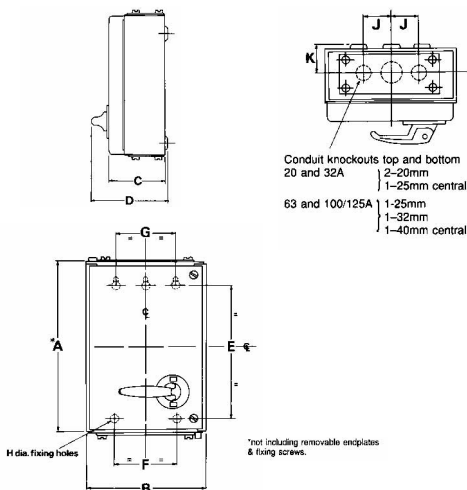

DIMENSIONS

CURRENT RATING A	A* mm	B mm	C mm	D mm	E mm	F mm	G mm	H mm	J mm	K mm
Switch-disconnectors										
20	159	193	92	127	112	114	onϕ	5.6	38.5	34
32	173	245	101	137	116	114	114	6.4	38.5	34
63	230	310	129	173	152	168	168	6.7	58	54
100/125	329	367	167	210	241	221	221	6.7	58	54
Switch-disconnector-fuses										
20	219	193	92	127	171	114	onϕ	5.6	38.5	34
32	267	245	101	137	209	114	114	6.4	38.5	34
63	351	310	129	173	273	168	168	6.7	58	54
100/125	503	367	167	210	416	221	221	6.7	58	54

EXEL 2 SPARES

Standard spares packs available via the sales office. Other spares are available on request.

DESCRIPTION	QUANTITY REQUIRED	LIST NO.
Moving contact assembly		
20A	1	0LV727SP
32A	1	0LV728SP
63A	1	0LV725SP
100/125A	1	0LV726SP
Switch base with arc shroud		
32A	1 per pole	230AXEBSP†
63A	1 per pole	260AXEBSP†
100/125A	1 per pole	2100AXEBSP†
100/125A	1 per pole	2100AXDEBSP

DESCRIPTION	QUANTITY REQUIRED	LIST NO.
Combined switch/fusebase with arc shroud		
32A	1 per pole	230KXEBS
63A	1 per pole	260KXEBS
Fusebase only		
100/125A	1 per pole	100MBDEBSP
Arc shroud only		
32A	1 per pole	SH265SP
63A	1 per pole	SH754SP
100/125A	1 per pole	CV1109SP

†1 required for switched neutral pole on SPSN switchfuses.



INDUSTRIAL SWITCH AND FUSE GEAR

SPSN SWITCHFUSE & MEMPROOF SWITCH - DISCONNECTORS



SPSN SWITCHFUSE

A surface mounting switch - disconnecter - fuse in rust-protected sheet steel with a light grey paint finish. Endplates incorporate dual concentric knockouts for cable entry. A hinged secondary cover allows access to switch and fuse carrier.

Designed for offset contact fuselinks to BS88: Part 2. The moulded fuse unit is shrouded to prevent accidental contact with live parts.

Units are supplied as standard with a 80A or 100A fuselink fitted List No. 80SO or 100SO. (2-63A SB3/SB4 fuselinks may be site fitted if required.)

A double pole isolating switch is fitted, type tested to BSEN60947-3 with a utilization category AC22A having a rated operational current I_e 240V and a conditional short circuit rating of 16kA.

A dolly locking device is available **List No. AL1** for use with padlock **List No. PD2**.

Maximum cable sizes are:- incoming cables 50mm², outgoing cables 35mm².

NOMINAL RATING I_e	LIST NO.
80A	80ESSCF
100A	100ESSCF

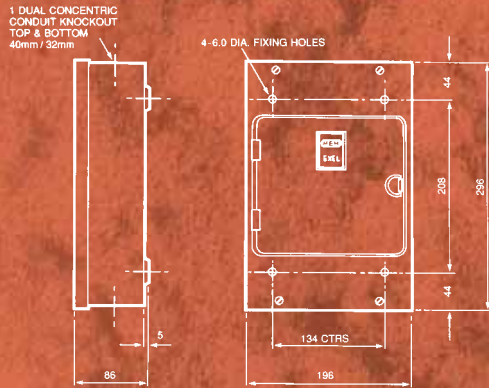

DIMENSIONS 100 ESSCF



MEMPROOF ENCLOSED DISCONNECTORS

Memproof enclosed switch - disconnectors are compliant with IEC 60947-3. The enclosures provide high impact resistance and have an IP57 rating. Each unit is supplied with fixed earth and isolating neutral and has facilities for locking.

NOMINAL RATING I_e	LIST NO.	DIMENSIONS (mm)		
		H	W	D
Double pole				
20A	MP202	165	82	81
35A	MP352	165	82	81
45A	MP452	165	82	81
63A	MP632	165	82	81
NOMINAL RATING I_e	LIST NO.	DIMENSIONS (mm)		
		H	W	D
Triple pole				
20A	MP203N	165	82	81
35A	MP353N	165	82	81
45A	MP453N	165	82	81
63A	MP633N	165	82	81

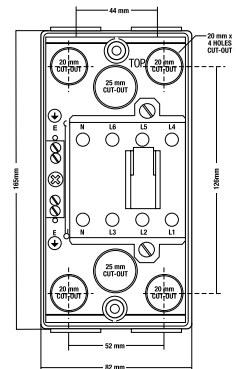

MEM LOK ON-LOAD CHANGEOVER SWITCHES

Suitable for on-load control of alternative supplies. Surface mounted, 4 pole on-load changeover switches have a rated voltage of 415V. Higher voltage ratings available, details on request.

Switches comply with BSEN60947-3, VDE0660. Double break blade & clip wiping action contact system ensures reduced contact bounce and the operator independent spring assisted mechanism ensures a positive and consistent switching action reducing arcing and contact wear.

32 - 200A units are provided with cable links and 400 - 800A with solid links suitable for use on either side of the switch. In all cases ample cable space is provided for both incoming and outgoing cables.

Each unit is provided with an IP54 black handle and steel operating shaft. All handles are insulated and may be padlocked in the 'OFF' position. Clear 'IN' (I) and 'OFF' (O) indication is provided. Door interlocking is provided by the handle in the 'ON' position.

Enclosures are finished in light grey.



NOMINAL RATING I _e	A mm	B mm	C mm	D mm	WEIGHT kg	LIST NUMBER
32A	320	372	170	225	9.6	432DA
63A	320	372	170	225	10.0	463DA
100A	370	372	170	225	10.6	4100DA
200A	474	460	320	375	25	4200DA
400A	800	550	245	300	46.4	4400DA
630A	800	650	245	300	47.0	4630DA
800A	800	650	245	300	51.0	4800DA

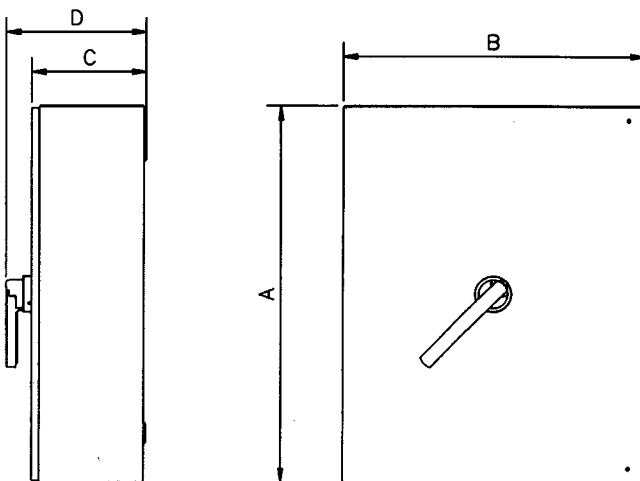

Note: Dimensions C & D measured from bottom of foot detail

INDUSTRIAL SWITCH AND FUSE GEAR MEMLOK & FIREMAN'S EMERGENCY SWITCHES



MEMLOK CHANGEOVER SWITCHES

Memlok changeover switches are available in non-padlockable moulded enclosures to IP65. Four pole two-way rotary cam switches comprise double break silver alloy contacts. Memlok units comply with BSEN60947-3.

NOMINAL RATING I _e	LIST NO.	CONDUIT KNOCKOUTS		DIMENSIONS (mm)		
		TOP	BOTTOM	H	W	D
Moulded four pole		ISO thread				
20A	200DAM	2 x 20	2 x 20	90	90	89★
25A	250DAM	2 x 20	2 x 20	90	90	115★
40A	400DAM	2 x 25	2 x 25	176	125	190★
		1 x 16	1 x 16			
63A	630DAM	2 x 25	2 x 25	176	125	190★
		1 x 16	1 x 16			

★Including operating handle.



FIREMAN'S EMERGENCY SWITCHES

DP switches have heavy duty cast iron enclosures finished in red, IP55. Surface and flush mounting versions available.

They comply with BS7671: 1992 (16th Edition of IEE Regulations) Clause 537 and 476-03-05 to 476-03-07. Switches are type-tested to BSEN60947-3 and have Utilization Category AC22, 250V.

They are of the quick make and break type, AC or DC. Pole operated ring handle automatically locks in the 'OFF' position.

White vitreous enamel nameplates with red lettering, for compliance with BS7671: 1992 Clause 537-04-06, of size 152mm x 102mm with 4-4.8mm fixing holes are available - **List No. 2FNP**.

For fire safety signs to BS5499-1 as required for Petrol Filling Stations under Health & Safety Executive Publication HS(G)41 reference should be made to specialist safety sign companies.

NOMINAL RATING I _e	LIST NO	DIMENSIONS mm			CONDUIT ENTRY TOP & BOTTOM
		H	W	D	
20A	215AF	143	159	102	1-20mm
20A (Flush)	220AFF*	178	165	132	1-20mm
32A	230AF	175	178	124	1-25mm

*Recess required: 136H x 124W x 73D (mm)

MAIN EARTHING TERMINAL BARS

Memform terminal bars are intended for the connection of circuit protective conductors, main bonding conductors and functional earthing conductors, etc., as referred to in IEE Wiring Regulation 542-04 (BS7671). A bolted link facilitates testing of earthing resistance. They are manufactured from solid hard drawn copper and mounted on painted steel supports complete with fixing holes and warning labels. For ease of installation all terminals are captive. Extra terminals are provided for supplementary bonding.

MAXIMUM INCOMER I _e	SIZE AND NUMBER OF TERMINALS EARTHING	PROTECTIVE BONDING	OVERALL LENGTH (mm)	OVERALL WIDTH (mm)	COPPER THICKNESS (mm)	LIST NO.
600A	1 x M10	3 x M10 2 x M6	320	32	31.75 x 6.35	600MEB
1000A	2 x M12 1 x M8	3 x M12 8 x M8	665	51	50.8 x 6.35	1000MEB

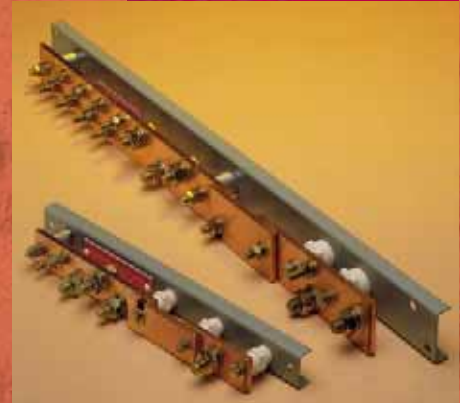

EARTH LEAD ADAPTORS

Intended for use with moulded enclosures. They allow earth continuity to be maintained by providing a flexible earth lead which can be terminated inside the enclosure. They are manufactured from brass.

- 20/20mm thread. **List No. 2020AFEW**
- 25/25mm thread. **List No. 2525AFEW**



GREY ENAMEL PAINT

Aerosol spray paint, air drying, dark grey to RAL 7015. **List No. 1AP.**
Light grey. **List No. 2AP**

Half-litre tin of dark grey enamel air drying paint to RAL 7015 for application by brush. **List No. 3EN.**

INDUSTRIAL SWITCH AND FUSEGEAR

EXEL DISTRIBUTION FUSEBOARDS



The Exel fuseboard range is available with standard enclosures to IP4X for the complete range of 20A to 200A distribution boards.

A variety of extra features have been incorporated in the range including increased cabling space, superior door latches and locking devices (there is a choice of barrel lock or padlocking device), improved lid hinges and a unique safety carrier which effectively blanks off a single fuse-way allowing the circuit to be worked on in safety. Safety carriers have no provision for accepting a fuselink.

The Exel distribution fuse boards are designed to comply with the requirements of BS5486: Part 11: 1989. All live parts are fully shrouded so that additional circuits may be wired and connected in safety whilst the existing circuits remain live and on load. The type of enclosure available gives protection to IP4X and is supplied with removable endplates.

The range covers a wide variety of ratings from 20-200A; 20A and 32A with up to 12 ways in SPN and TPN configurations; 63A up to 10 ways, 100A up to 8 ways and 200A up to 6 ways in TPN configurations.

All ratings available with moulded HRC carriers to BS88: Part 2. Testing has been carried out using Eaton MEM 'S' type HRC fuselinks.

The exclusive use of Eaton MEM fuselinks will extend the warranty period to 3 years.

Fuse base mouldings are of high quality thermosetting material. The fuse units have skirted fuse carriers to prevent accidental contact with live parts when inserting or withdrawing a carrier. Separate shields are provided for the base contacts to prevent accidental contact when the carrier has been withdrawn. All fuseboards are suitable for systems with a rated insulation voltage U_e 660V AC, 500V DC.

SAFETY CARRIERS

A range of safety carriers is available for insertion in a fusebase when its normal fuse carrier has been removed for isolation. The safety carriers are marked yellow for identification and have no provision for fuselink fixing.

ENCLOSURES

Rust protected sheet steel IP4X enclosures have a light grey paint finish and are fitted with internal fixing holes. Enclosures have a robust, reliable construction.

Enclosures for units from 20A to 100A are of all welded construction, 200A IP4X units have cast corner pieces. Removable top and bottom endplates incorporate knockouts on 20A and 32A units while 63-200A boards have blank endplates. Blank endplates are available on request for 20A and 32A boards.

The enclosure allows gasketed access doors to be reversed for left hand or right hand opening.

All sides are free from external projections and fuseboards can be mounted in inverted form if required.

MAIN TERMINATIONS

32A, 2-way fuseboards have the main phase termination (tunnel type) attached to the fusebanks. All other fuseboards have the main terminations mounted on the back of the enclosure and are intended for use with cable sockets (sweating or crimp type) which are not provided. Busbar and main terminals are fully shrouded. A cable shroud to cover the cable socket is provided.

Earthing and Neutral Bars

Multi-way earthing bars are fitted with an integral earth bolt and have an outgoing terminal per fuse. They are rail mounted adjacent to the fully rated neutral bars. Neutral bars have main terminals of the same capacity as the phase terminals and have one outgoing terminal per fuse. Earth/neutral bar rails are fitted at the bottom of enclosures on 20A and 32A fuseboards and at the top on all others.

ADDITIONAL OUTGOING CIRCUITS

All 20A and 32A units except 2-way versions have a main terminal suitable for looping out at full terminal capacity. This facility permits adjacent mounting of two fuseboards to extend outgoing circuits up to 24 way max. by the suggested method illustrated.

Additional shrouds (one per phase) required when using looping facility **List No. SH1539**.

LID LOCKING FACILITIES

A choice of locking device is available as follows:-

Barrel lock for 20A to 100A units

Padlock bracket for 20A to 100A units

Padlock bracket for 200A units

Padlock for use with above

List No. 1CLX

List No. 9LD

List No. 8LD

List No. PD1

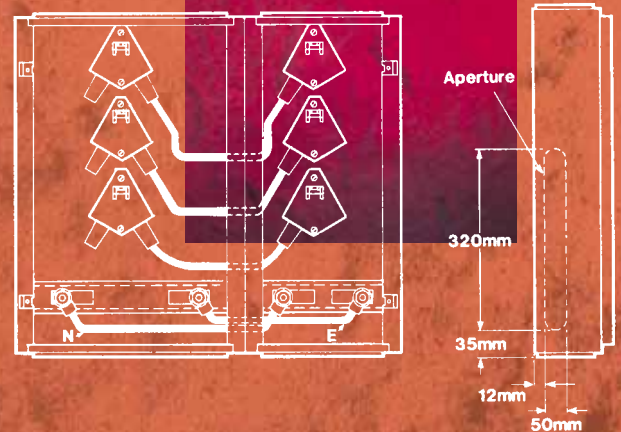

DIVERSITY FACTORS

MAXIMUM RATED OPERATIONAL CURRENT PER WAY Ie					
NO. OF WAYS	200A	100A	63A	32A	<20A
2	1.0	1.0	1.0	1.0	-
3	0.9	1.0	-	-	-
4	0.8	0.9	0.9	0.9	0.9
6	0.66	0.8	0.8	0.8	0.8
8	-	0.66	0.8	0.8	0.8
10	-	-	0.66	0.66	-
12	-	-	-	0.66	0.66
Therefore, incomer rating =					
2	400A	200A	126A	64A	-
3	540A	300A	-	-	-
4	640A	360A	227A	115A	72A
6	800A	480A	302A	154A	96A
8	-	528A	403A	205A	128A
10	-	-	416A	211A	-
12	-	-	-	253A	160A

EARTH BAR TERMINAL CAPACITIES

	NOMINAL RATING OF FUSEBOARD Ie				
	20A	32A	63A	100A	200A
Main (stud)	M10	M10	M10	M10	M10
Outgoing, mm ²	10	10	25	25	70

MAIN TERMINAL STUD SIZES

	WAYS	NOMINAL RATING OF FUSEBOARD Ie				
		20A	32A	63A	100A	200A
SPN	4	M10	M10	-	-	-
	6			-	-	-
	8			-	-	-
	12			-	-	-
TPN	2	-	★★	M12	M12	M16
	3	-	-			
	4	M10	M10	M16	M16	
	6					
	8					
	12					

★★Tunnel terminal 35mm² max.

EXEL SPARES

Standard spares packs available via the sales office. Other spares are available on request.

DESCRIPTION	LIST NO.
Earth bars	
20/32A fuseboards	
SP outgoing ways:	
up to 12	ETM2209SP
up to 18	ETM2210SP
up to 24	ETM2211SP
up to 36	ETM2212SP
Neutral bars	
20/32A fuseboards	
SP outgoing ways:	
up to 12	ETM2223SP
up to 18	ETM2224SP
up to 24	ETM2225SP
up to 36	ETM2226SP
Main incoming terminal block	
20/32A fuseboards	EBS843SP
Blank endplates	
20/32A fuseboards	
4/6 way boards	EP539
2/8 way boards	EP879
10/12 way 20A; 10 way 32A boards	EP880
12 way 32A boards	EP881



INDUSTRIAL SWITCH AND FUSEGEAR EXEL DISTRIBUTION FUSEBOARDS

All units are supplied without fuselinks which must be ordered separately.

NOMINAL RATING I _e	POLES	NO. OF WAYS	MAX. TERMINAL CAPACITY mm ² (COPPER CABLES) MAIN OUTGOING	OUTGOING TERMINAL BORE DIA. mm	SUITABLE H.R.C. FUSELINKS	SPARE FUSE CARRIER	SAFETY CARRIER	LIST NO. WITHOUT FUSELINKS							
IP4X Enclosures															
20A	SPN	4	95	6	4	SA2	20 MFH	20 MFS	204XSNC						
		6							206XSNC						
		8							208XSNC						
	TPN	12	120	6	4	SA2	20 MFH	20 MFS	212XSNC						
		4							204XTNC						
		6							206XTNC						
32A	SPN	8	150	16	5.5	SB3	32 MFH	32 MFS	212XTNC						
		12							304XSNC						
		2							35 (8mm dia.)	16	5.5	SB3 and SB4	32 MFH	32 MFS	306XSNC
		4													308XSNC
		6													312XSNC
		8													302XTNC
	10	304XTNC													
	12	306XTNC													
	63A	TPN	2	240	35	8	SB3 and SB4	63 MFH	63 MFS	308XTNC					
			4							310XTNC					
			6							312XTNC					
			8							602XTNC					
100A	TPN	2	240	70	12	SD5★	100 MFH	100 MFS	604XTNC						
		3							606XTNC						
		4							608XTNC						
		6							610XTNC						
200A	TPN	8	500†	150	18	SF6	200 MFH	200 MFS	1002XTNC						
		2							1003XTNC						
		3							1004XTNC						
		4							1006XTNC						
200A	TPN	6	630†	150	18	SF6	200 MFH	200 MFS	1008XTNC						
		2							2002XTNC						
200A	TPN	3	630†	150	18	SF6	200 MFH	200 MFS	2003XTNC						
		4							2004XTNC						
200A	TPN	6	630†	150	18	SF6	200 MFH	200 MFS	2006XTNC						
		2							2006XTNC						

★SB3, SB4 and S0 fuselinks may be fitted if used with adaptor - **List No. 100MFLK**

†Can be adapted to allow fitment of 2-240mm² max. cable sockets with suitable copper spacing piece **List No. WA1212** (set of 4) - see diagram.

Adaptor clips (set of 2) enabling fitment of house service ferrule cap fuselinks to BS1361: 1971 Type 11a (60A) and type 11b (100A) : **63MFRCL** for 63A fuse carriers, **100MFRCL** for 100A fuse carriers.

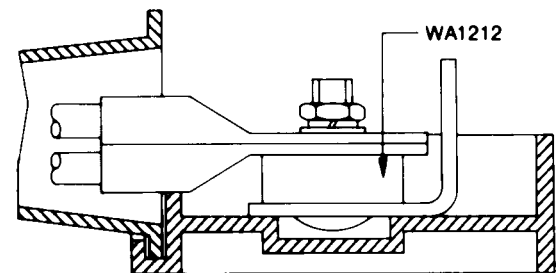

DIMENSIONS (MM) IP4X ENCLOSURES

NOMINAL RATING I _e	POLES	NUMBER OF WAYS	A	B	C	D CRS	E CRS	F DIA.		
20A	SPN	4	386	304	148	252	191	8		
		6		304			191			
		8		368			255			
	TPN	12	448	335						
		4	304	191						
		6	304	191						
32A	SPN	8	386	368	148	252	255	8		
		12		496			383			
		TPN		2			368		255	
				4			304		191	
				6			304		191	
				8			368		255	
	10		448	335						
	12		496	383						
	63A	TPN	2	546	473	227	458		369	10
			4	330	226					
			6	972	330		884		226	
			8	473	369					
100A			TPN	10	473		369			
				2	546		549	458	445	
100A	TPN	3	1066	330	227	978	226	10		
		4		330			226			
		6		549			445			
		8		549			445			
200A	TPN	2	1560	410	270	1334	206	10		
		3		410			206			
		4		529			325			
		6		529			325			

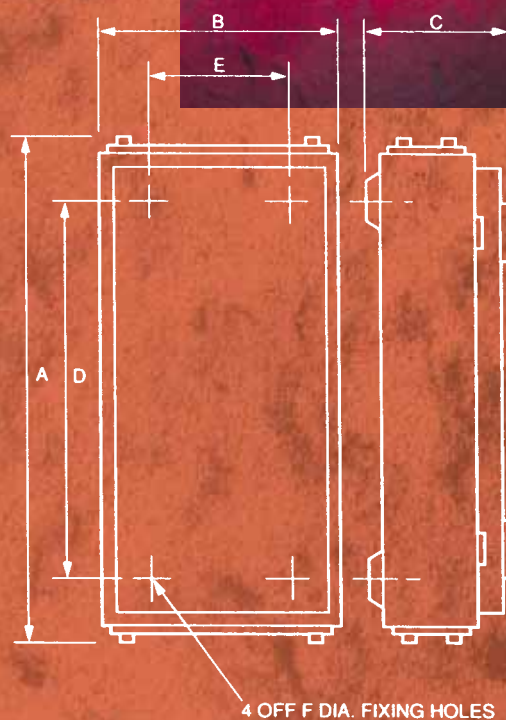

PARAMOUNT HRC CARTRIDGE FUSELINKS & FUSE UNITS

- The leading edge of HRC fuse technology
- Options to suit every application
- Compact 415V fuselinks
- NEW ferrule fuselinks
- New F type semi-conductor fuselinks
- Breaking capacity of 80kA at 415V
- Motor rated fuselinks
- New compact moulded HRC fuse units...
- Fully shrouded for safety
- For bolt-in & clip-in fuselinks

Eaton MEM's technical ability coupled with recent investment in manufacturing technology has led to being able to offer an extensive range of up to date designs at the leading edge of fuse technology including...

- New general purpose 415V a.c. 29 x 12.7mm ferrule fuselinks complying with BS EN 60269-1 (BS88: Part 1) and BS7654 with ratings from 2-32A. For use in industrial and commercial installations.
- New F type semiconductor protection fuselinks complying with IEC 60269-4 and BS88: Part 4. Ratings from 6-900A at 240V a.c. and 6-710A at 660/690V a.c. For the protection of semiconductor devices requiring high speed disconnection from faults.

Our comprehensive range offers a selection of fuses to cater for many applications:

Compact 415V a.c. S type industrial fuselinks complying with BS EN 60269-1 (BS88: part 1) or BS88: Part 2 with ratings from 2 to 1250A. Skilful design techniques have meant that power dissipation has frequently been reduced despite the significant reduction in barrel size. Many ratings have also been tested for use in circuits up to 250V d.c.

Compact 415V a.c. S type motor circuit protection fuselinks complying with BS EN 60269-1 (BS88: part 1) or BS88: Part 2 with ratings from 20M25A to 400M500A. This extended range of fuselinks is designed to withstand the inrush current associated with direct on line start motors whilst saving cost on the size of equipment to which they are fitted by virtue of their small dimensions.

Compact 240V and 415V a.c. SS, SN and SP type offset blade contact fuselinks complying with BS EN 60269-1 (BS88: part 1) or BS88: Part 6 with ratings from 2 to 63A for use in industrial and commercial installations.

550V a.c. S type industrial fuselinks complying with BS EN 60269-1 (BS88: part 1) or BS88: Part 2 with ratings from 2 to 800A are also available in the most commonly used fixing centres. Also rated at 250V d.c.

Compact 415V a.c. J type feeder pillar fuselinks complying with BS88: Part 5 for use by the Electricity Supply Industry in distribution systems. Ratings from 63-400A with 82mm fixing centres and 63-800A with 92mm fixing centres for wedge tightening contacts and 63-250A in ferrule form for single phase pole mounted cut outs.

NH type blade contact 500V a.c. fuselinks complying with IEC 60269-2-1 section 1 and with dimensions also to DIN43620/1. Ratings from 6-630A in size C00 to size 4. For use in industrial applications where European practice prevails.

Eaton MEM HRC fuselinks are manufactured to exacting standards using precision assembly methods and undergo rigorous quality checking before dispatch including resistance testing all production. This ensures that performance will be consistent and conform with published characteristics within close tolerances. Type tests on Eaton MEM equipment have been performed using Eaton MEM fuselinks and the exclusive use of Eaton MEM fuselinks in Eaton MEM equipment will extend the warranty period to 3 years.

Eaton MEM industrial and general purpose fuselinks have a breaking range and utilization category gG which replaces the old class Q1 fusing factor. "g" indicates a full range breaking capacity fuselink and "G" indicates a fuselink for general application.

Eaton MEM motor circuit protection fuselinks have a breaking range and utilization category gM indicating a full range breaking capacity fuselink for the protection of motor circuits. These fuselinks have a dual current rating separated by the letter "M".

The lower current rating is the maximum continuous rating which also determines the rating and size of equipment to which the fuse is fitted. The higher current rating is the time current characteristic of the fuselink which determines its ability to withstand the motor starting current. Their selection frequently permits the use of lower rated switch and/or fusegear than would be the case using gG fuselinks with a consequent cost saving. Type gG fuselinks however may still be used and are the preferred option for assisted start motors where starting currents are reduced.

Technical information for these products is available from Eaton MEM's Customer Services Department.

Eaton MEM fuselinks are designed and manufactured in accordance with a Quality Management System in accordance with ISO 9001 assessed by BSI. Most fuselinks are ASTA Certified for a breaking capacity of 80kA at 415V or 550V a.c. and are endorsed ASTA 20 CERT showing compliance with the rules of the ASTA 20 scheme which includes assessment of the Quality Management System to ISO 9002 and detailed auditing of fuselink manufacture.

Eaton MEM have for many years participated in developing and influencing fuse standards through EIEMA and BSI at national level and IEC at international level and therefore are able to produce designs incorporating forthcoming changes to standards.

415V INDUSTRIAL FUSELINKS

S-Type compact industrial bolted pattern fuselinks with offset contacts.
 ASTA 20 Certified or tested to BS EN 60269-1 (BS88: Part 1) or BS88:
 Part 2 for a breaking capacity of 80 kA at 415V a.c.

- These industrial bolted pattern fuselinks are of two types - with offset contacts of ratings 2-200A and with centre contacts of ratings 2-1250A.
- They are available to BS references A1 to A4, B1 to B4, C1 to C3, D1 and in certain other sizes.

RATING Ie NORMAL	MOTOR	FIXING CENTRES (mm)	BS88 REF	LIST NO.	DIMENSIONAL EQUIVALENTS				
					GEC/LAWSON	BRUSH/HAWKER	BUSSMANN/DORMAN		
2A	-	44.5	A1	2SA2	NIT2	2F21	NITD2		
4A	-			4SA2	NIT4	4F21	NITD4		
6A	-			6SA2	NIT6	6F21	NITD6		
10A	-			10SA2	NIT10	10F21	NITD10		
16A	-			16SA2	NIT16	16F21	NITD16		
20A	-			20SA2	NIT20	20F21	NITD20		
20A	25A			20SA2M25	NIT20M25	20M25F21	NITD20M25		
20A	32A			20SA2M32	NIT20M32	20M32F21	NITD20M32		
25A	-			25SA2	NIT25	25F21	NITD25		
32A	-			32SA2	NIT32	32F21	NITD32		
32A	40A			32SA2M40	NIT32M40	-	NITD32M40		
32A	50A			32SA2M50	NIT32M50	-	NITD32M50		
32A	63A			32SA2M63	NIT32M63	-	NITD32M63		
2A	-			73	A2	2SB3	TIA2	2H07	AA02
4A	-	4SB3	TIA4			4H07	AA04		
6A	-	6SB3	TIA6			6H07	AA06		
10A	-	10SB3	TIA10			10H07	AA010		
16A	-	16SB3	TIA16			16H07	AA016		
20A	-	20SB3	TIA20			20H07	AA020		
25A	-	25SB3	TIA25			25H07	AA025		
32A	-	32SB3	TIA32			32H07	AA032		
32A	40A	32SB3M40	TIA32M40			32M40H07	AA032M40		
32A	50A	32SB3M50	TIA32M50			32M50H07	AA032M50		
32A	63A	32SB3M63	TIA32M63			32M63H07	AA032M63		
35A	-	73	A3			35SB4	TIS35	-	-
40A	-					40SB4	TIS40	40K07	BA040
50A	-					50SB4	TIS50	50K07	BA050
63A	-			63SB4	TIS63	63K07	BA063		
63A	80A			63SB4M80	TIS63M80	63M80K07	BA063M80		
63A	100A			63SB4M100	TIS63M100	63M100K07	BA063M100		
80A	-			80SO	OS80/TIS80	80K07R	OSD80		
100A	-			100SO	OS100/TIS100	100K07R	OSD100		
100A	125A			100SOM125	OS100M125/TIS100M125	-	OSD100M125		
100A	160A			100SOM160	-	-	OSD100M160		
125A	-			125SO	OOT125	-	-		
160A	-			160SO	OOT160	-	-		
200A	-			200SO	-	-	-		
32A	-			94	A4	32SD5	TCP32	32L14	CE035
40A	-	40SD5	TCP40			40L14	CE040		
50A	-	50SD5	TCP50			50L14	CE050		
63A	-	63SD5	TCP63			63L14	CE063		
80A	-	80SD5	TCP80			80L14	CE080		
100A	-	100SD5	TCP100			100L14	CE0100		
100A	125A	100SD5M125	TCP100M125			100M125L14	CE0100M125		
100A	160A	100SD5M160	TCP100M160			100M160L14	CE0100M160		
100A	200A	100SD5M200	TCP100M200			100M200L14	CE0100M200		
125A	-	125SD6	TFP125			125M14	DE0125		
160A	-	160SD6	TFP160			160M14	DE0160		
200A	-	200SD6	TFP200			200M14	DE0200		
200A	250A	200SD6M250	TFP200M250			200M250M14	DE0200M250		
200A	315A	200SD6M315	-			-	-		

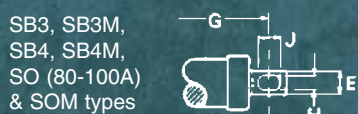
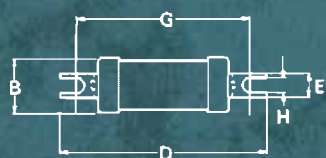
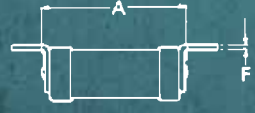

SB3, SB3M,
 SB4, SB4M,
 SO (80-100A)
 & SOM types

DIMENSIONS

LIST NO	A MAX. mm	B MAX. mm	D MAX. mm	E mm	F mm	G NOM. mm	H MM	J MM
SA2	33	14	54	11	0.8	44.5	4.8	-
SA2M (25-40A)	33	14	54	11	0.8	44.5	4.8	-
SA2M (50-63A)	36	17.5	55	11	1.2	44.5	4.8	-
SB3	34	14	86	9	1.2	73	5.5	8
SB3M	38	17	86	9	1.2	73	5.5	8
SB4	38	17	86	9	1.2	73	5.5	8
SB4M	45	27	91	13	1.6	73	5.8	10
SO (80-100A)	45	27	91	13	1.6	73	5.8	10
SOM	45	27	91	13	1.6	73	5.8	10
SO (125-200A)	48	30	90	19	3.2	73	5.8	-
SD5	48	27	111	16	3.2	94	9	-
SD5M	48	30	111	19	3.2	94	9	-
SD6	48	30	111	16	3.2	94	9	-
SD6M	48	40	111	19	3.2	94	9	-



PARAMOUNT HRC CARTRIDGE FUSELINKS & FUSE UNITS

550V INDUSTRIAL FUSELINKS

S-Type industrial bolted pattern fuselinks with offset contacts. ASTA 20 Certified or tested to BS EN 60269-1 (BS88: Part 1) or BS88: Part 2 for a breaking capacity of 80 kA at 550V a.c.



RATING I _e NORMAL	MOTOR	FIXING CENTRES mm	BS88 REF	LIST NO.	DIMENSIONAL EQUIVALENTS		
					GEC/LAWSON	BRUSH/HAWKER	BUSSMANN/DORMAN
2A	-	44.5	A1	2SA2-550	NIT2	2F21	NITD2
4A	-			4SA2-550	NIT4	4F21	NITD4
6A	-			6SA2-550	NIT6	6F21	NITD6
10A	-			10SA2-550	NIT10	10F21	NITD10
16A	-			16SA2-550	NIT16	16F21	NITD16
20A	-			20SA2-550	NIT20	20F21	NITD20
2A	-	73	A2	2SB3-550	TIA2	2H07	AA02
4A	-			4SB3-550	TIA4	4H07	AA04
6A	-			6SB3-550	TIA6	6H07	AA06
10A	-			10SB3-550	TIA10	10H07	AA010
16A	-			16SB3-550	TIA16	16H07	AA016
20A	-			20SB3-550	TIA20	20H07	AA020
25A	-			25SB3-550	TIA25	25H07	AA025
32A	-	32SB3-550	TIA32	32H07	AA032		
40A	-	73	A3	40SB4-550	TIS40	40K07	BA040
50A	-			50SB4-550	TIS50	50K07	BA050
63A	-			63SB4-550	TIS63	63K07	BA063
80A	-	94	A4	80SD5-550	TCP80	80L14	CE080
100A	-			100SD5-550	TCP100	100L14	CE0100
125A	-	94		125SD6-550	TFP125	125M14	DE0125
160A	-			160SD6-550	TFP160	160M14	DE0160
200A	-			200SD6-550	TFP200	200M14	DE0200

DIMENSIONS

FUSE LINK TYPE	A MAX. mm	B MAX. mm	D MAX. mm	E mm	F mm	G NOM. mm	H mm	J mm
SA2-550	36	14	55	11	0.8	44.5	4.8	-
SB3-550 SB4-550	56	21	86	9	1.2	73	5.5	7.5
SD5-550								
SD6-550	77	41	110	19	2.4	94	8.7	10.3

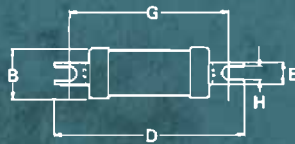
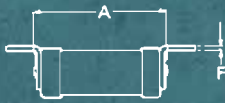

SB3, SB4,
SD6, types
only



415V INDUSTRIAL FUSELINKS

S-Type compact industrial bolted pattern fuselinks with centre contacts. ASTA 20 Certified or tested to BS EN 60269-1 (BS88: Part 1) or BS88: Part 2 for a breaking capacity of 80 kA at 415V a.c.

RATING Ie NORMAL	MOTOR	FIXING CENTRES mm	BS88 REF	LIST NO.	DIMENSIONAL EQUIVALENTS		
					GEC/LAWSON	BRUSH/HAWKER	BUSSMANN/DORMAN
2A	-	97	-	2SE3	TB2	2K08	AC2
4A	-			4SE3	TB4	4K08	AC4
6A	-			6SE3	TB6	6K08	AC6
10A	-			10SE3	TB10	10K08	AC10
16A	-			16SE3	TB16	16K08	AC16
20A	-			20SE3	TB20	20K08	AC20
25A	-			25SE3	TB25	25K08	AC25
32A	-			32SE3	TB32	32K08	AC32
2A	-			111	-	2SF3	TBC2
4A	-	4SF3	TBC4			4K09	AD4
6A	-	6SF3	TBC6			6K09	AD6
10A	-	10SF3	TBC10			10K09	AD10
16A	-	16SF3	TBC16			16K09	AD16
20A	-	20SF3	TBC20			20K09	AD20
25A	-	25SF3	TBC25			25K09	AD25
32A	-	32SF3	TBC32			32K09	AD32
40A	-	97	-			40SE4	TB40
50A	-			50SE4	TB50	50K08	BC50
63A	-			63SE4	TB63	63K08	BC63
63A	80A	97	-	63SE4M80	-	-	-
63A	100A			63SE4M100	-	-	-
40A	-	111	B1	40SF4	TBC40	40K09	BD40
50A	-			50SF4	TBC50	50K09	BD50
63A	-			63SF4	TBC63	63K09	BD63
63A	80A	111	B1	63SF4M80	-	-	-
63A	100A			63SF4M100	-	-	-
80A	-	111	B1	80SF5	TC80	80L09	CD80
100A	-			100SF5	TC100	100L09	CD100
100A	125A			100SF5M125	TC100M125	100M125L09	CD100M125
100A	160A			100SF5M160	TC100M160	100M160L09	CD100M160
100A	200A			100SF5M200	TC100M200	100M200L09	CD100M200
125A	-	111	B2	125SF6	TF125	125M09	DD125
160A	-			160SF6	TF160	160M09	DD160
200A	-			200SF6	TF200	200M09	DD200
200A	250A			200SF6M250	TF200M250	200M250M09	DD200M250
200A	315A			200SF6M315	-	-	-
250A	-	111	B3	250SF7	TKF250	250N09	ED250
315A	-			315SF7	TKF315	315N09	ED315
315A	400A			315SF7M400	-	-	-
250A	-	133	-	250SG7	TKM250	250N11	EF3250
315A	-			315SG7	TKM315	315N11	EF3315
355A	-	111	B4	355SF8	TMF355	355P09	ED355
400A	-			400SF8	TMF400	400P09	ED400
400A	500A			400SF8M500	TMF400M500	-	ED400M500
355A	-	133/ 184	C1	355SH8	TM355	355P11	EF355
400A	-			400SH8	TM400	400P11	EF400
450A	-	-	-	450SF9	3T450	-	-
500A	-			500SF9	3T500	-	-
560A	-			560SF9	3T560	-	-
630A	-	-	-	630SF9	3T630	-	-
450A	-			450SH9	TTM450	450R11	FF450
500A	-			500SH9	TTM500	500R11	FF500
560A	-	133/ 184	C2	560SH9	TTM560	560R11	FF560
630A	-			630SH9	TTM630	630R11	FF630
450A	-	165/229	-	450SY9	TT450	450R12	FG450
500A	-			500SY9	TT500	500R12	FG500
560A	-			560SY9	TT560	560R12	GG560
630A	-			630SY9	TT630	630R12	GG630
710A	-	133/ 184	C3	710SH10	TLM710	700S11	GF710
800A	-			800SH10	TLM800	800S11	GF800
710A	-	165/229	-	710SY10	TLT710	700S12	GG700
800A	-			800SY10	TLT800	800S12	GG800
1000A	-	149	D1	1000SJ11	TXU1000	1000U44	GH1000
1250A	-			1250SJ11	TXU1250	1250U44	GH1250



MEM

PARAMOUNT HRC CARTRIDGE FUSELINKS & FUSE UNITS

415V INDUSTRIAL FUSELINKS – DIMENSIONS

DIMENSIONS

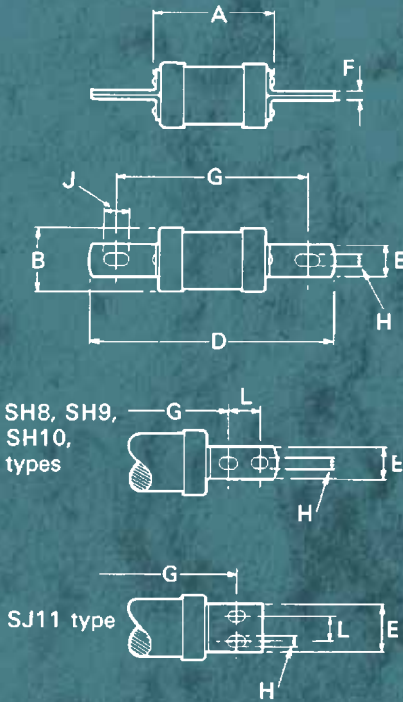

FUSE LINK TYPE	A MAX. mm	B MAX. mm	D MAX. mm	E mm	F mm	G NOM. mm	H mm	J mm	L mm
SE3	57	21	116	13	1.6	97	7.2	11	-
SF3	57	21	136	16	2.0	111	8.7	16	-
SE4	57	21	116	13	1.6	97	7.2	11	-
SF4	57	21	136	16	2.0	111	8.7	16	-
SE4M	57	26	116	13	1.6	97	7.2	11	-
SF4M	58	26	136	16	3.2	111	8.7	16	-
SF5	48	27	134	16	3.2	111	9	12.5	-
SF5M	48	30	137	19	3.2	111	9	12.5	-
SF6	48	30	137	19	3.2	111	9	12.5	-
SF6M	48	40	137	19	3.2	111	9	12.5	-
SF7	48	40	137	19	3.2	111	9	12.5	-
SF7M	51	40	138	25	5.0	111	9	12.5	-
SG7	48	40	159	19	3.2	133	10.5	14	-
SF8	51	40	138	25	5.0	111	9	12.5	-
SF8M	59	53	138	25	6.3	111	9	18	-
SH8	51	40	211	25	5.0	133	10.5	14	25.4
SF9 (450-500A)	59	53	138	25	6.3	111	9	18	-
SF9 (560-630A)	59	63	138	25	6.3	111	9	18	-
SH9 (450-500A)	59	53	212	25	6.3	133	10.5	14	25.4
SH9 (560-630A)	59	63	212	25	6.3	133	10.5	14	25.4
SY9	59	63	266	38	6.4	165	10	16	32
SH10	57	63	212	25	10	133	10.5	14	25.4
SY10	59	63	267	38	10	165	10	16	32
SJ11	83	100	198	63.5	9.5	149	14.3	19	32

550V INDUSTRIAL FUSELINKS

S-Type industrial bolted pattern fuselinks with centre contacts. ASTA 20 Certified or tested to BS EN 60269-1 (BS88: Part 1) or BS88: Part 2 for a breaking capacity of 80 kA at 550V a.c.



RATING Ie NORMAL	MOTOR	FIXING CENTRES	BS88 REF	LIST NO.	DIMENSIONAL EQUIVALENTS		
					GEC/LAWSON	BRUSH/HAWKER	BUSSMANN/DORMAN
80A	-	111	B1	80SF5-550	TC80	80L09	CD80
100A	-	111	B2	100SF5-550	TC100	100L09	CD100
125A	-			125SF6-550	TF125	125M09	DD125
160A	-			160SF6-550	TF160	160M09	DD160
200A	-	111	B3	200SF6-550	TF200	200M09	DD200
250A	-			250SF7-550	TKF250	250N09	ED250
315A	-			315SF7-550	TKF315	315N09	ED315
250A	-	133	-	250SG7-550	TKM250	250N11	EFS250
315A	-			315SG7-550	TKM315	315N11	EFS315
355A	-	111	B4	355SF8-550	TMF355	355P09	ED355
400A	-			400SF8-550	TMF400	400P09	ED400
355A	-	133/184	C1	355SH8-550	TM355	355P11	EF355
400A	-			400SH8-550	TM400	400P11	EF400
450A	-	133/184	C2	450SH9-550	TTM450	450R11	FF450
500A	-			500SH9-550	TTM500	500R11	FF500
560A	-			560SH9-550	TTM560	560R11	GF550
630A	-	133/184	C3	630SH9-550	TTM630	630R11	GF630
710A	-			710SH10-550	TLM710	700S11	GF700
800A	-	800SH10-550	TLM800	800S11	GF800		

DIMENSIONS

LIST NO.	A MAX. mm	B MAX. mm	D MAX. mm	E mm	F mm	G NOM. mm	H mm	J mm	L mm
SF5-550	66	36	134	19	3.6	111	8.7	16	-
SF6-550	76	41	136	19	3.6	111	8.7	16	-
SF7-550	75	51	137	26	4	111	8.7	16	-
SG7-550	75	51	159	26	4	133	10	16	-
SF8-550	81	59	136	26	5.2	111	8.7	16	-
SH8-550	81	59	210	26	5.2	133	10	16	25
SH9-550	82	74	210	26	6.4	133	10	16	25
SY9-550	82	74	266	38	6.4	165	10	16	32
SH10-550	84	83	210	26	10	133	10	16	25
SY10-550	84	83	267	38	10	165	10	16	32

SN TYPE OFFSET BLADE FUSELINKS

ASTA 20 Certified or tested to BS EN 60269-1 (BS88: Part 1) and BS88: Part 6 for a breaking capacity of 80 kA at 415V a.c. For use in industrial and commercial installations.

RATING Ie NORMAL MTR	OVERALL LENGTH mm	OVERALL DIA. mm	LIST NO.	EQUIVALENTS		
				GEC/LAWSON	BRUSH/HAWKER	BUSSMANN/DORMAN
2A -	60	14	2SN2	NS2	2F06	NSD2
4A -			4SN2	NS4	4F06	NSD4
6A -			6SN2	NS6	6F06	NSD6
10A -			10SN2	NS10	10F06	NSD10
16A -			16SN2	NS16	16F06	NSD16
20A -			20SN2	NS20	20F06	NSD20
20A 25A			20SN2M25	NS20M25	20M25F06	NSD20M25
20A 32A			20SN2M32	NS20M32	20M32F06	NSD20M32
25A -			25SN2	NS25	25F06	NSD25
32A -			32SN2	NS32	32F06	NSD32
32A 40A	58	17.5	32SN2M40	NS32M40	-	NSD32M40
32A 50A			32SN2M50	NS32M50	-	NSD32M50
32A 63A			32SN2M63	NS32M63	-	NSD32M63



SP TYPE OFFSET BLADE FUSELINKS

ASTA 20 Certified to BS EN 60269-1 (BS88: Part 1) and BS88: Part 6 for a breaking capacity of 80 kA at 415V a.c. For use in industrial and commercial installations.

RATING Ie	OVERALL LENGTH mm	OVERALL DIA. mm	LIST NO.	EQUIVALENTS		
				GEC/LAWSON	BRUSH/HAWKER	BUSSMANN/DORMAN
16A	68	17	16SP	-	-	ESD16
20A			20SP	-	-	ESD20
25A			25SP	-	-	ESD25
32A			32SP	-	-	ESD32
40A			40SP	40ES	40G05	ESD40
50A			50SP	50ES	50G05	ESD50
63A			63SP	63ES	63G05	ESD63



R AND RL TYPE HOUSE SERVICE CUT-OUT FUSELINKS

Type IIa (R) and IIb (RL) house service cut-out fuse links. ASTA 20 Certified or tested to BS1361 for a breaking capacity of 33 kA at 415V a.c.

For use in domestic and commercial installations mainly in supply authorities cut-outs.

RATING Ie	OVERALL LENGTH mm	OVERALL DIA. mm	LIST NO.	GEC	EQUIVALENTS	
					HAWKER/ BUSSMANN	DORMAN
15A	57	22.23	154R	RHF15	15KR85	-
20A			204R	RHF20	20KR85	-
30A			304R	RHF30	30KR85	RHD30
40A			404R	RHF40	40KR85	RHD40
45A			454R	-	45KR85	-
50A			504R	RHF50	50KR85	RHD50
60A			604R	RHF60	60KR85	RHD60
80A			804R	RHF80	80KR85	RHD80
100A			1004R	-	100KR85	-
30A			57	30	304RL	RHL30
60A	604RL	RHL60			60LR85	RHLD60
80A	804RL	RHL80			80LR85	RHLD80
100A	1004RL	RHL100			100LR85	RHLD100



LC TYPE FUSELINKS

Type I domestic consumer unit fuse links. Tested to BS1361 (or BS88: Part 1 for non-standard ratings) for a breaking capacity of 16.5 kA at 240V a.c.

For use in domestic and commercial installations mainly for lighting and heating circuits.

RATING Ie	OVERALL LENGTH mm	OVERALL DIA. mm	COLOUR CODE	LIST NO.	CARTON QTY.	EQUIVALENTS	
						GEC	DORMAN
5A	23	6.35	White	5LC	100	D55	DSD5
5A	26	10.32	Black	1505LC	50	-	-
6A	29	12.70	Black	3006LC	20	-	-
10A	26	10.32	Black	1510LC	50	-	-
10A	29	12.70	Black	3010LC	50	-	-
15A	26	10.32	Blue	15LC	50	D1515	DSD15
16A	29	12.70	Black	3016LC	20	-	-
20A	26	10.32	Yellow	20LC	50	D1520	DSD20
20A	29	12.70	Black	3020LC	50	-	-
25A	29	12.70	Black	3025LC	20	-	-
30A	29	12.70	Red	30LC	50	D3030	DSD30
35A	35	16.67	Black	35LCS	10	-	-
40A	35	16.67	Black	40LCS	10	-	-
45A	35	16.67	Green	45LCS	10	D4545	DSD45



PARAMOUNT HRC CARTRIDGE FUSELINKS & FUSE UNITS

LS TYPE STREET LIGHTING FUSELINKS

ASTA 20 Certified to BS EN 60269-1 (BS88: Part 1) for a breaking capacity of 50 kA at 240V a.c. Also complies with BS7654.

For use in street lighting cut-outs.



RATING Ie	FIXING CENTRES mm	OVERALL LENGTH mm	OVERALL DIA. mm	LIST NO.	EQUIVALENTS*		
					GEC	BRUSH	DORMAN/ BUSSMANN
LS-Type, offset contacts							
2A	38	49	14	2LS	LST2	2D19L	STD2
4A				4LS	LST4	4D19L	STD4
6A				6LS	LST6	6D19L	STD6
10A				10LS	LST10	10D19L	STD10
16A				16LS	LST16	16D19L	STD16
20A				20LS	LST20	20D19L	STD20
25A				25LS	LST25	25D19L	STD25
32A				32LS	LST32	32D19L	STD32

SS TYPE OFFSET BLADE FUSELINKS

ASTA 20 Certified to BS EN 60269-1 (BS88: Part 1) and BS88: Part 6 for a breaking capacity of 50 kA at 240V a.c.

For use in industrial and commercial installations mainly for lighting and heating circuits.



RATING Ie	FIXING CENTRES mm	OVERALL LENGTH mm	OVERALL DIA. mm	LIST NO.	EQUIVALENTS*		
					GEC/ LAWSON	BRUSH	DORMAN/ BUSSMANN
2A	-	51	14	2SS	SS2	2D04	SSD2
4A				4SS	SS4	4D04	SSD4
6A				6SS	SS6	6D04	SSD6
10A				10SS	SS10	10D04	SSD10
16A				16SS	SS16	16D04	SSD15
20A				20SS	SS20	20D04	SSD20
25A				25SS	SS25	25D04	SSD25
32A				32SS	SS32	32D04	SSD32

DR TYPE GENERAL PURPOSE FUSELINKS

ASTA 20 Certified to BS EN 60269-1 (BS88: Part 1) for a breaking capacity of 80 kA at 415V a.c. Also complies with BS7654.

For general purpose use in industrial and commercial installations.



RATING Ie	FIXING CENTRES mm	OVERALL LENGTH mm	OVERALL DIA. mm	LIST NO.	EQUIVALENTS*		
					GEC/ LAWSON	BRUSH	DORMAN/ BUSSMANN
2A	-	29	12.7	2DR	MD2	-	-
4A				4DR	MD4	-	-
6A				6DR	MD6	-	-
8A				8DR	MD8	-	-
10A				10DR	MD10	-	-
12A				12DR	-	-	-
16A				16DR	MD16	-	-
20A				20DR	MD20	-	-
25A				25DR	MD25	-	-
32A				32DR	MD32	-	-

*Equivalent columns list fuselinks having similar ratings and fixing centres.

NH-TYPE DIN KNIFE BLADE FUSELINKS

Tested to IEC 60269-2-1 section 1 for a breaking capacity of 120 kA at 500V a.c. with dimensions also to DIN43620/1.

For use in industrial applications where European practice prevails.

	RATING Ie	LENGTH O/A mm	LIST NO.	COOPER BUSSMANN	EQUIVALENTS LEGRAND	GEC
SIZE 00C	6A	78.5	NHC006	NHC00B	-	-
	10A	78.5	NHC0010	NHC00B	-	NHG00C
	16A	78.5	NHC0016	NHC00B	-	NHG00C
	20A	78.5	NHC0020	NHC00B	-	NHG00C
	25A	78.5	NHC0025	NHC00B	-	NHG00C
	32A	78.5	NHC0032	NHC00B	-	NHG00C
	35A	78.5	NHC0035	NHC00B	-	NHG00C
	40A	78.5	NHC0040	NHC00B	-	NHG00C
	50A	78.5	NHC0050	NHC00B	-	NHG00C
	63A	78.5	NHC0063	NHC00B	-	NHG00C
	80A	78.5	NHC0080	NHC00B	-	NHG00C
100A	78.5	NHC00100	NHC00B	-	NHG00C	
SIZE 00	125A	78.5	NH00125	NH00B	163	NHG00
	160A	78.5	NH00160	NH00B	163	NHG00
SIZE 1	25A	133.0	NH0125	NH1B	173	NHG1
	35A	133.0	NH0135	NH1B	173	NHG1
	50A	133.0	NH0150	NH1B	173	NHG1
	63A	133.0	NH0163	NH1B	173	NHG1
	80A	133.0	NH0180	NH1B	173	NHG1
	100A	133.0	NH01100	NH1B	173	NHG1
	125A	133.0	NH01125	NH1B	173	NHG1
	160A	133.0	NH01160	NH1B	173	NHG1
	200A	133.0	NH01200	NH1B	173	NHG1
	224A	133.0	NH01224	NH1B	173	NHG1
	250A	133.0	NH01250	NH1B	173	NHG1
SIZE 2	25A	148.0	NH0225	NH2B	178	NHG2
	35A	148.0	NH0235	NH2B	178	NHG2
	50A	148.0	NH0250	NH2B	178	NHG2
	63A	148.0	NH0263	NH2B	178	NHG2
	80A	148.0	NH0280	NH2B	178	NHG2
	100A	148.0	NH02100	NH2B	178	NHG2
	125A	148.0	NH02125	NH2B	178	NHG2
	160A	148.0	NH02160	NH2B	178	NHG2
	200A	148.0	NH02200	NH2B	178	NHG2
	224A	148.0	NH02224	NH2B	178	NHG2
	250A	148.0	NH02250	NH2B	178	NHG2
	315A	148.0	NH02315	NH2B	178	NHG2
	355A	148.0	NH02355	NH2B	178	NHG2
	400A	148.0	NH02400	NH2B	178	NHG2
SIZE 3	315A	150.0	NH03315	NH3B	181	NHG3
	355A	150.0	NH03355	NH3B	181	NHG3
	400A	150.0	NH03400	NH3B	181	NHG3
	500A	150.0	NH03500	NH3B	181	NHG3
	630A	150.0	NH03630	NH3B	181	NHG3

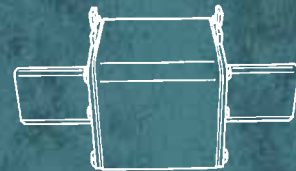
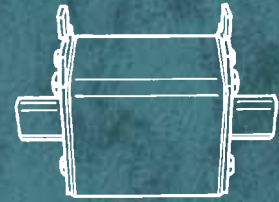

Neutral links, handles and other ratings and dimensions of fuselinks for use on the L.V. distribution network are available - details on request.

Neutral Links: KS 00, KS 01, KS 02, KS 03. Handle: NHH

PARAMOUNT HRC CARTRIDGE FUSELINKS & FUSE UNITS

J-TYPE FEEDER PILLAR FUSELINKS

ASTA 20 Certified or tested to BS88: Part 5 for a breaking capacity of 80 kA at 415V a.c.

Available in standard 82mm and 92mm fixing centres up to 400A and 800A respectively for wedge tightening contacts. Also available in ferrule form up to 250A for pole mounted cut-outs.

For use by the Electricity Supply Industry in distribution systems.

Available with silver elements, details on request.

RATING Ie	FIXING CENTRES mm	LIST NO.	EQUIVALENTS						
			FLUVENT	LAWSON	SIBA	GEC	EMP	BUSSMANN/ BRUSH	DORMAN
63A	82	63JCS82	DL2-2	JPU	5002301	JP	2/EJA	MJ30	JPD
80A		80JCS82	DL2-2	JPU	5002301	JP	2/EJA	MJ30	JPD
100A		100JCS82	DL2-2	JPU	5002301	JP	2/EJA	MJ30	JPD
125A		125JCS82	DL2-2	JPU	5002301	JP	2/EJA	MJ30	JPD
160A		160JCS82	DL2-2	JPU	5002301	JP	2/EJA	MJ30	JPD
200A		200JCS82	DL2-2	JPU	5002301	JP	2/EJA	MJ30	JPD
250A		250JCS82	DL2-2	JPU	5002301	JP	2/EJA	MJ30	JPD
315A		315JCS82	DL2-2	JPU	5002301	JP	2/EJA	MJ30	JPD
355A		355JCS82	DL2-2	JPU	5002301	JP	2/EJA	PJ30	JPD
400A		400JCS82	DL2-2	JPU	5002301	JP	2/EJA	PJ30	JPD
63A	92	63JCS92	DL3-2	JSU	5002601	JS	3/EJB	MJ31	JSD
80A		80JCS92	DL3-2	JSU	5002601	JS	3/EJB	MJ31	JSD
100A		100JCS92	DL3-2	JSU	5002601	JS	3/EJB	MJ31	JSD
125A		125JCS92	DL3-2	JSU	5002601	JS	3/EJB	MJ31	JSD
160A		160JCS92	DL3-2	JSU	5002601	JS	3/EJB	MJ31	JSD
200A		200JCS92	DL3-2	JSU	5002601	JS	3/EJB	MJ31	JSD
250A		250JCS92	DL3-2	JSU	5002601	JS	3/EJB	MJ31	JSD
315A		315JCS92	DL3-2	JSU	5002601	JS	3/EJB	MJ31	JSD
355A		355JCS92	DL3-2	JSU	5002601	JS	3/EJB	PJ31	JSD
400A		400JCS92	DL3-2	JSU	5002601	JS	3/EJB	PJ31	JSD
450A		450JCS92	DL3-2	JSU	5002601	JS	3/EJB	RJ31	JSD
500A		500JCS92	DL3-2	JSU	5002601	JS	3/EJB	RJ31	JSD
560A		560JCS92	DL3-2	JSU	5002601	JS	3/EJB	SJ31	JSD
630A		630JCS92	DL3-2	JSU	5002601	JS	3/EJB	SJ31	JSD
710A		710JCS92	DL3-2	JSU	5002601	JS	3/EJB	SJ31	JSD
800A		800JCS92	DL3-2	JSU	5002601	JS	3/EJB	SJ31	JSD
Ferrule cap type									
63A		63JCF	-	JF	5005701	FHLA	-	MJ25	-
80A		80JCF	-	JF	5005701	FHLA	-	MJ25	-
100A		100JCF	-	JF	5005701	FHLA	-	MJ25	-
125A		125JCF	-	JF	5005701	FHLA	-	MJ25	-
160A		160JCF	-	JF	5005701	FHLA	-	MJ25	-
200A		200JCF	-	JF	5005701	FHLA	-	MJ25	-
250A		250JCF	-	JF	5005701	FHLA	-	MJ25	-



240V F TYPE SEMI-CONDUCTOR PROTECTION FUSELINKS

Tested to BS88: Part 4 and IEC 60269-4 for a breaking capacity of 100 kA at 240V a.c.

For the protection of semi-conductor devices requiring high speed protection from faults.

RATING I _e	FIXING CENTRES mm	LIST NO.	BUSSMANN	GEC	INTERNATIONAL RECTIRIER	DORMAN	FERRAZ	SIBA
6	37	6FMA	6LCT	GSA5	A350-5	DSA5	2.5URE 10/6	50-076-06/5
10	37	10FMA	10LCT	GSA10	A350-10	DSA10	2.5URE 10/10	50-076-06/10
12	37	12FMA	12LCT	-	A350-12	DSA12	2.5URE 10/12	-
16	37	16FMA	16LCT	GSA15	A350-16	DSA16	2.5URE 10/15	50-076-06/16
20	37	20FMA	20LCT	GSA20	A350-20	DSA20	2.5URE 10/20	50-076-06/20
7	40.4	7FNA	7LET	-	L350-7	DSL7	2.5URGS 17/7	50-053-06/7
10	40.4	10FNA	10LET	-	L350-10	DSL10	2.5URGS 17/10	50-053-06/10
12	40.4	12FNA	12LET	-	L350-12	DSL12	2.5URGS 17/12	-
16	40.4	16FNA	16LET	-	L350-16	DSL16	2.5URGS 17/16	50-053-06/16
20	40.4	20FNA	20LET	-	L350-20	DSL20	2.5URGS 17/20	50-053-06/20
25	40.4	25FNA	25LET	GSA25	L350-25	DSL25	2.5URGS 17/25	50-053-06/25
32	40.4	32FNA	32LET	-	L350-32	DSL32	2.5URGS 17/32	50-053-06/32
35	40.4	35FNA	35LET	GSA35	L350-35	DSL35	2.5URGS 17/35	50-053-06/35
50	40.4	50FNA	50LET	GSA50	L350-50	DSL50	2.5URGS 17/50	50-053-06/50
63	40.4	63FNA	63LET	-	L350-63	DSL63	2.5URGS 17/63	50-053-06/63
80	40.4	80FNA	80LET	-	L350-80	DSL80	2.5URGS 17/100	50-053-06/80
100	40.4	100FNA	100LET	GSA100	L350-100	DSL100	2.5URZ 17/125	50-053-06/100
125	40.4	125FNA	125LET	GSA125	L350-125	DSL125	2.5URZ 17/160	50-053-06/125
160	40.4	160FNA	160LET	GSA160	L350-160	DSL160	2.5URZ 17/180	50-053-06/160
180	40.4	180FNA	180LET	-	L350-175	DSL180	2.5URZ 17/150	50-053-06/180
160	56.9	160FPA	160LMT	GSA150	T350-150	DST160	2.5URGG 36/200	50-054-06/150
200	56.9	200FPA	200LMT	GSA200	T350-200	DST200	2.5URGG 36/250	50-054-06/200
250	56.9	250FPA	250LMT	GSA250	T350-250	DST250	2.5URGG 36/300	50-054-06/250
315	56.9	315FPA	315LMT	GSD315	T350-315	DST315	2.5URGG 36/315	50-054-06/315
355	56.9	355FPA	355LMT	GSD355	T350-350	DST355	2.5URGG 36/350	50-054-06/350
400	56.9	400FPA	400LMT	-	T350-2400	DST400	2.5URGG 36/400	50-054-06/400
450	56.9	450FPA	450LMT	-	T350-450	DST450	2.5URGG 36/450	-
400	56.9	400FPA2	400LMMT	-	TT350-400	DSTT400	2.5URGH 236/400	50-072-06/400
500	56.9	500FPA2	500LMMT	GSA500	TT350-500	DSTT500	2.5URGH 236/500	50-072-06/500
630	56.9	630FPA2	630LMMT	GSA630	TT350-630	DSTT630	2.5URGH 236/600	50-072-06/630
710	56.9	710FPA2	710LMMT	GSD710	TT350-710	DST710	2.5URGH 236/700	50-072-06/710
800	56.9	800FPA2	800LMMT	-	TT350-800	DSTT800	2.5URGH 236/800	50-072-06/800
900	56.9	900FPA2	900LMMT	-	TT350-900	DSTT900	2.5URGH 236/900	50-072-06/900

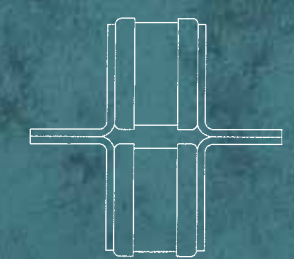
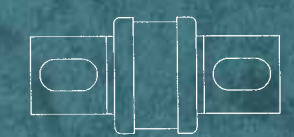

DIMENSIONS (MM)

FUSELINKS TYPE	OVERALL LENGTH	BODY LENGTH	BODY DIAMETER	TAG WIDTH	TAG THICKNESS	DETAIL IF MULTI BARREL
FMA	45.6	28	10.3	6.40	0.80	
FNA	55.6	25.5	18	12.70	2	
FPA	82	32	37.3	25	2.5	
FPA2	82	32	37.3	25	5	TWO BODIES BACK TO BACK

PARAMOUNT HRC CARTRIDGE FUSELINKS & FUSE UNITS

660V F TYPE SEMI-CONDUCTOR PROTECTION FUSELINKS

Tested to BS88: Part 4 and IEC 60269-4 for a breaking capacity of 200 kA at 660V a.c.

For the protection of semi-conductor devices requiring high speed protection from faults.

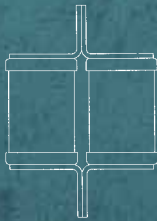

CURRENT RATING	FIXING CENTRES mm	LIST NO.	GEC	GEC	BUSSMANN	INTERNATIONAL RECTIFIER	DORMAN	FERRAZ	SIBA
6	64	6FSB	GSB5	-	6CT	B1000-5	DSB5	6.6URE 10/6	50-077-06/5
10	64	10FSB	GSB10	-	10CT	B1000-10	DSB10	6.6URE 10/10	50-077-06/10
12	64	12FSB	-	-	12CT	B1000-12	DSB12	6.6URE 10/12	-
16	64	16FSB	GSB16	-	16CT	B1000-16	DSB16	6.6URE 10/15	50-077-06/16
20	64	20FSB	GSB20	-	20CT	B1000-20	DSB20	6.6URE 10/20	50-077-06/20
8	63.2	8FRB	-	-	8ET	E1000-8	DSG8	-	-
10	63.2	10FRB	-	-	10ET	E1000-10	DSG10	-	50-073-06/10
16	63.2	16FRB	-	GSGB16	15ET	E1000-15	DSG15	6.6URS 17/16	50-073-06/16
20	63.2	20FRB	-	-	20ET	E1000-20	DSG20	6.6URS 17/20	50-073-06/20
25	63.2	25FRB	GSB25	GSGB25	25ET	E1000-25	DSG25	6.6URS 17/25	50-073-06/25
32	63.2	32FRB	-	GSGB30	32ET	E1000-32	DSG32	6.6URS 17/32	50-073-06/32
35	63.2	35FRB	-	GSGB35	35ET	E1000-35	DSG35	6.6URS 17/35	50-073-06/35
40	63.2	40FRB	-	GSGB40	40ET	E1000-40	DSG40	6.6URS 17/40	50-073-06/40
45	63.2	45FRB	GSB45	GSGB45	45ET	E1000-45	DSG45	6.6URS 17/45	50-073-06/45
56	63.2	56FRB	-	GSGB55	56ET	E1000-56	DSG55	6.6URS 17/55	50-073-06/55
63	63.2	63FRB	-	GSGB63	63ET	E1000-63	DSG63	6.6URS 17/63	50-073-06/63
80	63.2	80FRB	GSB80	GSGB80	80ET	E1000-80	DSG80	6.6URS 17/80	50-073-06/80
65	69.2	65FTB2	-	-	63EET	EE1000-65	DSGG65	6.6URT 217/65	-
75	69.2	75FTB2	-	GSGB75	75EET	EE1000-75	DSGG75	6.6URT 217/75	-
90	69.2	90FTB2	-	GSGB75	90EET	EE1000-90	DSGG90	6.6URT 217/90	-
110	69.2	110FTB2	-	GSGB110	110EET	EE1000-110	DSGG110	6.6URT 217/110	-
140	69.2	140FTB2	-	GSGB150	140EET	EE1000-140	DSGG140	6.6URT 217/140	-
160	69.2	160FTB2	-	GSGB160	160EET	EE1000-160	DSGG160	6.6URT 217/160	-
160	84.9	160FUB	GSB100	-	160MT	M1000-160	DSM160	6.6URGL 36/50	50-074-06/150
180	84.9	180FUB	-	GSGB170	180MT	M1000-180	DSM180	6.6URGL 36/180	50-074-06/180
200	84.9	200FUB	GSB200	GSGB200	200MT	M1000-200	DSM200	6.6URGL 36/200	50-074-06/200
250	84.9	250FUB	GSB250	GSGB250	250MT	M1000-250	DSM250	6.6URGL 36/250	50-074-06/250
280	84.9	280FUB	-	-	280MT	-	DSM280	6.6URGL 36/280	50-074-06/280
315	84.9	315FUB	-	-	315MT	M1000-315	DSM315	6.6URGL 36/315	50-074-06/315
355	84.9	355FUB	-	-	355MT	M1000-355	DSM355	6.6URGL 36/355	50-074-06/355
180	84.9	180FUB2	-	GSGB175	180MMT	MM1000-180	DSMM180	6.6URGM 236/175	50-075-06/180
200	84.9	200FUB2	-	GSGB200	200MMT	MM1000-235	DSMM225	6.6URU 236/200	50-075-06/200
225	84.9	225FUB2	-	GSGB235	225MMT	MM1000-225	DSMM225	6.6URR 236/235	50-075-06/225
280	84.9	280FUB2	-	-	280MMT	-	DSMM280	6.6URGM 236/300	50-075-06/280
315	84.9	315FUB2	GSB300	GSGB300	315MMT	MM1000-315	DSMM315	6.6URGM 236/325	50-075-06/300
355	84.9	355FUB2	-	GSGB350	355MMT	MM1000-355	DSMM355	6.6URGM 236/355	50-075-06/350
400	84.9	400FUB2	GSB400	GSGB400	400MMT	MM1000-400	DSMM400	6.6URU 246/400	50-075-06/400
450	84.9	450FUB2	-	GSGB450	450MMT	MM1000-450	DSMM450	6.6URGM 236/450	50-075-06/450
500	84.9	500FUB2	GSB500	GSGB500	500MMT	MM1000-500	DSMM500	6.6URGM 236/500	50-075-06/500
560	84.9	560FUB2	-	-	560MMT	MM1000-560	DSMM560	-	-
630	84.9	630FUB2	-	-	630MMT	MM1000-630	DSMM630	6.6URGM 236/630	50-075-06/630
710	84.9	710FUB2	-	-	710MMT	MM1000-710	DSMM710	6.6URGM 236/710	50-075-06/710

FUSELINKS TYPE	OVERALL LENGTH	BODY LENGTH	BODY DIAMETER	TAG WIDTH	TAG THICKNESS	DETAIL IF MULTI BARREL
FSB	72.6	50.8	10.3	6.4	0.8	
FRB	77.2	47.2	18	12.7	2	
FTB2	90.2	46.2	18	30	1.5	TWO BODIES SIDE BY SIDE
FUB	110	60	37.3	25	2.5	
FUB2	110	60	37.3	25	5	TWO BODIES BACK TO BACK

FUSE CARRIERS AND BASES, REWIRABLE AND HRC TYPES

Types MBA and MBB fuse bases, type MRH rewirable fuse carriers and 100A HRC fuse carriers (List No. 100 SCHF) are manufactured from high grade vitreous porcelain.

HRC fuse carriers up to and including 100A (List Nos. 2 SCHF, 3 SCHF, 6 SCHF, 10 SCHF) comprise black track-resistant mouldings.

HRC and rewirable pattern carriers of the same rating are interchangeable.

Fuse bases are available in two types:

Type A - providing for busbar connection at one end and cable termination at the other.

Type B - providing for cable connection at both ends.

Terminal capacities for Type A and Type B bases:- 20A 6mm², 32A 10mm², 63A 35mm², 100A 70mm².

Rewirable fuse carriers are of the semi-enclosed type, and when fitted in Eaton MEM enclosures comply with the following 415/250V Categories of duty of BS 3036: 1958.

20, 32 and 63A - Category S2A.

100A - Category S4A.

100A fuse units may be fitted with SB3, SB4 or S0 fuselinks having 73mm fixing centres if used with adaptor List No. 100 MFLK HRC fuse carriers are designed for standard offset contact fuse links to BS88: Part 2 and are suitable for systems up to 660V.

All performance tests have been carried out using Eaton MEM BS 88 Fuselinks.

The exclusive use of Eaton MEM Fuselinks will extend the warranty period to 3 years.

HRC fuse carriers and bases comply with the requirements of Lloyds Register of Shipping and are included in Schedules A and B of their List of Approved Fuses.

FUSE CARRIERS

NOMINAL RATING I _e	LIST NO.	LIST NO.	MEM HRC FUSES FITTED
	REWIRABLE	HRC	
10A	15 MRH2★	1 SCHF★★	10SA2
20A	15 MRH2★	2 SCHF★★	20SA2
32A	32 MRH2★	3 SCHF★★	32SB3
63A	63 MRH2★	6 SCHF★★	63SB4
100A	100 MRH2★	10 SCHF★★	100SD5
		100 SCHF★	

★Porcelain ★★Moulded

DIMENSIONS

NOMINAL RATING I _e	A	B	C1	C2	D	E	F
mm	mm	mm	mm	mm	mm	mm	mm
20A	75	29	56	52	*	68	4.8
32A	106	35	60	68	41	105	5.2
63A	132	46	86	90	41	129	5.6
100A	165	60	116	121	57	162	6.8

*20A fuses have a single fixing hole on the centre line.

C1 applies to base fitted with rewirable carrier, C2 to base fitted with HRC carrier.



FUSE BASES

NOMINAL RATING I _e	LIST NO.	LIST NO.
	TYPE A	TYPE B
20A	15 MBA2	15 MBB2
32A	32 MBA2	32 MBB2
63A	63 MBA2	63 MBB2
100A	100 MBA2	100 MBB2

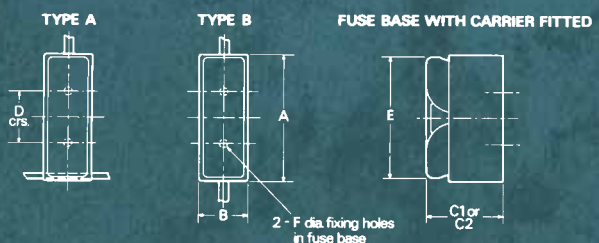

PARAMOUNT HRC CARTRIDGE FUSELINKS & FUSE UNITS

MOULDED HRC FUSE UNITS, BOLT-IN AND CLIP-IN TYPES

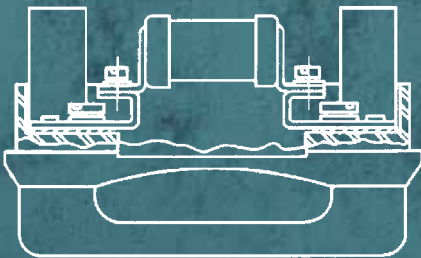

SPECIFICATION

A range of moulded HRC fuse units designed to accept bolt-in and clip-in HRC fuselinks.

Each unit is fully shrouded to prevent accidental contact with live parts when inserting or withdrawing a carrier and once the carrier has been removed completely.

The carrier and base mouldings are manufactured from high quality thermosetting material finished in black. Other colours are available.

Units accepting bolt-in HRC fuselinks are available in ratings of 20, 32, 63, 100 and 200A and can be supplied in front connected, front/busbar connected, front/back connected and back connected versions.

They are designed to comply with BS88: Part 2, 1988 and are suitable for systems up to 660V. Suitable HRC fuselinks are also to BS88: Part 2: 1988. A full range of neutral links is available.

The exclusive use of Eaton MEM Fuselinks will extend the warranty period to 3 years.

Those units which accept the clip-in fuselinks are rated at 32A and 63A, 415V. Each in a front connected and front/back connected version, with a 32A back/back type also available. Also suitable for DIN-rail mounting.

They comply with BS88: Part 1: 1988 and accept clip-in HRC fuselinks to the same standard.

Clip-in type units allow fuselinks to be replaced very simply - no tools are required. Fuselinks are removed from the carrier using side pressure on the fuselink end tags while replacement involves a simple push fit only. Neutral links are available.

Terminal capacities:

20A 6mm², 32A 16mm², 63A 35mm², 100A 70mm², 200A 150mm².

Fuse units are available in four types:

Type A - providing for busbar connection at one end and cable termination at the other.

Type B - providing for cable connection at each end.

Type C - with back connecting studs.

Type D - providing for cable connection at one end with back connecting stud at the other.

Fuse units have been ASTA certified for type tests to BS88: Part 2 and are suitable for systems up to 660V.

Fuse units comply with the requirements of Lloyds Register of Shipping and are included in schedule A of their List of Approved Fuses.

100A fuse units may be fitted with SB3, SB4 or S0 fuselinks having 73mm fixing centres if used with adaptor 100MFLK.

COMPLETE FUSE UNITS (CARRIERS AND BASES)

NOMINAL RATING I _e	COLOUR	LIST NO. ACCORDING TO TYPE OF CONNECTION							NEUTRAL LINK LIST NO. CLIP-IN		SUITABLE MEM HRC FUSELINKS BOLT-IN CLIP-IN	
		BOLT-IN TYPE TYPE A FRONT/BUSBAR	TYPE B FRONT/FRONT	TYPE C BACK/BACK	TYPE D FRONT/BACK	FRONT/FRONT	FRONT/BACK	BACK/BACK	BOLT-IN	CLIP-IN	BOLT-IN	CLIP-IN
20A	Black White	20MFA -	20MFB 20MFBW	20MFC 20MFCW	20MFD -	- -	- -	- -	20MLK	- -	2-20SA2 2-20SA2	- -
32A	Black White	32MFA -	32MFB 32MFBW	32MFC 32MFCW	32MFD -	32CFF 32CFFW	32CFB 32CFBW	32CBB 32CBBW	32MLK	32CLK 32CLK	2-32SB3 2-32SB3	2-32SN2 2-32SN2
63A	Black White	63MFA -	63MFB 63MFBW	63MFC 63MFCW	63MFD -	63CFF 63CFFW	63CFB 63CFBW	- -	63MLK	63CLK 63CLK	2-32SB3 35-63SB4 154-604R*	16-63SP
100A	Black White	100MFA -	100MFB 100MFBW	100MFC 100MFCW	100MFD -	- -	- -	- -	100MLK	- -	2-32SB3† 35-63SB4† 80-100S0† 80-100SD5	-
200A	Black White	200MFA -	200MFB 200MFBW	200MFC 200MFCW	200MFD -	- -	- -	- -	200MLK	- -	2-32SF3 40-63SF4 80-100SF5 125-200SF6	-
COMPACT RANGE												
32A	Black White	32CMFA -	32CMFB 32CMFBW	32CMFC 32CMFCW	32CMFD -	- -	- -	- -	20MLK	- -	2-32SA2 2-32SA2	- -
63A	Black White	63CMFA -	63CMFB 63CMFBW	63CMFC 63CMFCW	63CMFD -	- -	- -	- -	32MLK	- -	2-32SB3 35-63SB4	- -
100A	Black White	100CMFA -	100CMFB 100CMFBW	100CMFC 100CMFCW	100CMFD -	- -	- -	- -	63MLK	- -	35-63SB4 80-100S0	- -
200A	Black White	200CMFA -	200CMFB 200CMFBW	200CMFC 200CMFCW	200CMFD -	- -	- -	- -	100MLK	- -	80-100SD5 125-200SD6	- -
315A	Black White	315CMFA -	315CMFB 315CMFBW	315CMFC 315CMFCW	315CMFD -	- -	- -	- -	200MLK	- -	125-200SF6 250-315SF7	- -

†SB3, SB4 or S0 fuselinks may be fitted if used with adaptor - **List No. 100MFLK**.

*R-Type (22.2mm dia.) ferrule cap fuselinks may be fitted if used with adaptor clips (set of 2) **List No. 63MFRCL**.

These adaptor clips are also suitable for 100A units if used together with **100MFLK**. Ferrule cap HRC Fuselinks (30.2mm dia.) to BS 1361: 1971, type IIb may be fitted to 100A units if used with adaptor clips (set of 2) **List No. 100MFRCL**.

Note: Carriers available for NH fuses - details on request. Memshield 2 fuse carrier range also available.

DIMENSIONS

NOMINAL RATING I _e	A	B	C	D	E	F	G	H	J	K	L	M	HOLE DIA. TO ACCEPT INSULATED STUD (TYPES C AND D) mm MIN
	mm	mm	mm	mm	mm	mm	mm	mm	mm	mm	mm	mm	
20A	87	79	27	50	63	56	6	5.5	-	-	-	-	12
32A	109	101	31	62	60	78	6	5.5	12.7	6.4	-	-	12
32A clip-in	75	-	25	57.7	40	-	6	5.5	-	-	4.4	28.5	12
63A	118	110	35	72	71	79	8	5.5	12.7	6.4	-	-	14.5
63A clip-in	88.7	-	31.5	66.34	71	-	8	5.5	-	-	4.8	31.6	14.5
100A	154	154	54	108	80	117	10	6.5	19	22	-	-	18.5
200A	193	193	70	149	89	138	12	7.0	38	57	-	-	24.5
COMPACT RANGE													
32A	87	79	27	50	63	56	6	5.5	-	-	-	-	12
63A	109	101	31	62	60	78	6	5.5	12.7	6.4	-	-	12
100A	118	110	35	72	71	79	8	5.5	12.7	6.4	-	-	14.5
200A	154	154	54	108	80	117	10	6.5	19	22	-	-	18.5
315A	193	193	70	149	89	138	12	7.0	38	57	-	-	24.5

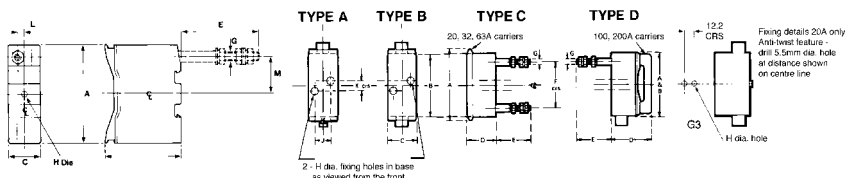

MEM

PANEL MOUNTING SWITCHGEAR FUSED COMBINATION SWITCHES, 32-800A



Fused combination switches from 32-800A and switch-disconnectors in six frame sizes from 45-1000A. Units will accommodate BS88 and DIN fuselinks. Unique side operating versions are available for draw out motor control applications or for use where space is restricted.

The range complies with BSEN60947-3, VDE0660 and is both ASTA and KEMA approved.

SPECIFICATION

Each fused combination switch and switch-disconnector has been designed to provide a high performance switch rating in both distribution (AC22) and motor control (AC23) applications.

Six compact frame sizes cover nominal ratings from 32 to 800A in double, triple and four pole configurations.

The exclusive use of Eaton MEM Fuselinks will extend the warranty period to 3 years.

Steel components have a zinc plate and full chromate passivation finish to BS1706-ZN3. Copper termination bars are silver plated.

The range of switches complies with BSEN60947-3, VDE0660 and has been ASTA certified to category of duty AC23.

FEATURES

MECHANISM

The operator independent spring assisted mechanism ensures a positive and consistent switching action reducing arcing and contact wear.

CONTACTS

The double break, blade and clip wiping action contact system ensures reduced contact bounce and provides load breaking isolating contacts either side of the fuselink.

Fuselinks remain stationary providing a high level of mechanical reliability for the fuse and contact system. Long contact life is combined with high performance for both a.c. and d.c. supplies.

CONTACT POSITION INDICATION

Each operating handle positively indicates the position of the contacts. Complete fuse isolation is achieved in the 'OFF' position. Handles cannot be returned to 'OFF' if any contacts in any pole become welded.

A contact position indicator is fitted to each switch giving positive indication of contact position, this is clearly visible when the door is open.

COMPACT SIZE

The high performance contact system achieves maximum ratings for both distribution and motor control applications within a very compact size thus saving valuable panel space.

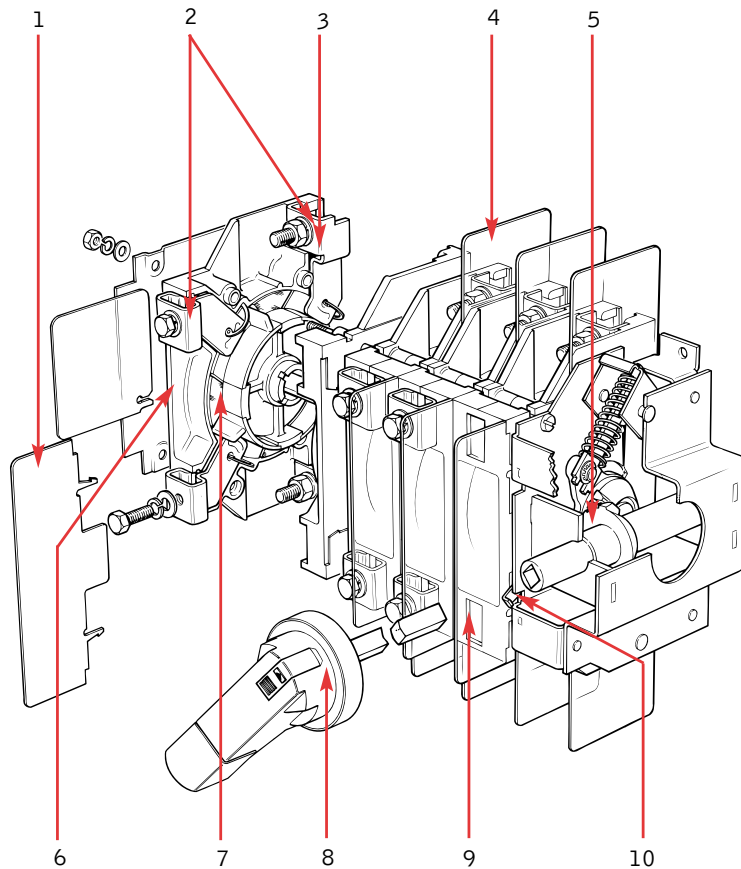

1. Polycarbonate inter-phase shields.
2. Fixed contacts.
3. 63-800A terminations are provided for easy attachment of cable lugs or solid copper connections.
4. Polycarbonate snap-fastening connection barriers.
5. Manually independent over centre spring switching mechanism.
6. Contact system provides four breaks in series per phase.
7. Moving contacts.
8. Fully interlocked rotary action operating handle. Interlock may be overridden by a competent operator for inspection and maintenance.
9. Choice of switched (neutral makes first, breaks last) or solid neutrals.
10. Positive contact indicator shows contact position with door open.

PANEL MOUNTING SWITCHGEAR

FUSED COMBINATION SWITCHES SPECIFICATION

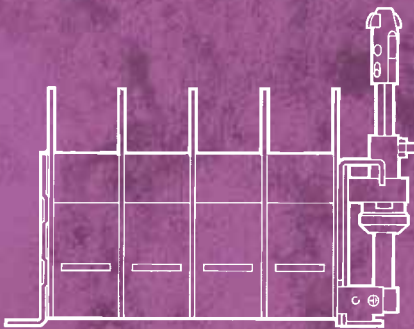
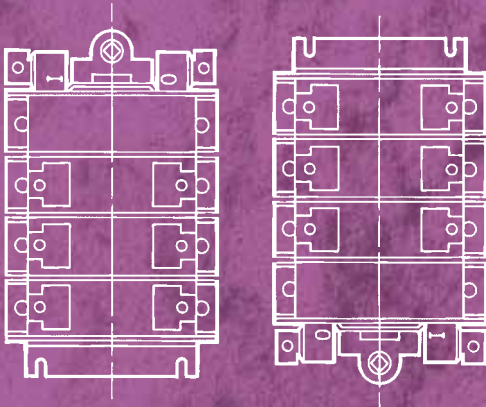
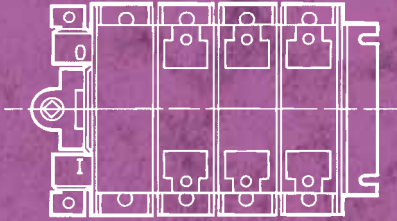

Mounting Positions

OPERATING SEQUENCE:

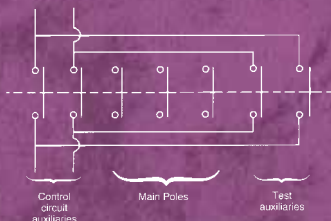

HANDLES AND SHAFTS

Each switch is provided as standard with an IP54 black handle and steel operating shaft. For switches up to 400A handles are moulded, 800A and above are cast metal. Clear 'ON' (I) and 'OFF' (O) indication is provided and padlocks may be fitted in the 'OFF' position.

Door interlocking provided by the handle in the 'ON' position is defeatable by a competent person to enable access in emergencies and for maintenance purposes.

Operating shafts have flexible arrow-heads to aid handle alignment and panel depth adjustment.

TERMINALS

32-63A rated fuse-switches are fitted with box clamp terminals for copper cables (solid, stranded or flexible, prepared or unprepared) up to 25mm². 100A fuse-switches and above have silverplated copper terminals to accept cable or solid conductor connections.

32A fuse-switches have inherent terminal shrouds designed to prevent accidental finger contact. Additional polycarbonate terminal shrouds are available for all ratings and configurations.

SIDE OPERATING VERSIONS

Triple pole ratings up to 160A are available as side operating versions. These are particularly suitable for draw out motor control applications or where narrow form enclosures may be required.

MOUNTING POSITIONS

Switches may be mounted in the positions illustrated without need for derating. All switches are designed for base mounting.

RATING LABELS

For convenience, a second rating label is supplied with each switch for separate mounting where visual access to technical data is impaired.

NEUTRALS

Neutrals (switched or solid) are situated next to the switch mechanism. Units can be supplied with neutrals positioned at the furthest pole position from the mechanism. Suffix order references /D1.

TEST SWITCHES

Triple pole switches up to 400A can be supplied with three positions; 'ON' - 'OFF' - 'TEST' where test auxiliaries only are operated at the third ('TEST') position. The additional auxiliaries are mounted on the mechanism side and are parallel wired to standard auxiliaries or used as required.

Black handles are supplied having three positions and switches are door interlocked in 'TEST' and 'ON' positions - defeatable by competent personnel.

Auxiliaries are supplied separately for mounting on 'TEST' and 'STANDARD' positions up to the maximum indicated. Mounting packs are required for auxiliaries.

	OFF	ON	TEST
MAIN POLES	OPEN	CLOSED	OPEN
AUX.	OPEN	CLOSED	OPEN
TEST AUX.	OPEN	OPEN	CLOSED

ORDER REFERENCES

BS Fuse Version - Standard Operation

FRAME SIZE	ENCLOSED RATING I _{th}	OPEN RATING I _{th}	AC22	AC23	MEM FUSE	SINGLE POLE AND BOLTED NEUTRAL, SPN	SINGLE POLE AND SWITCHED NEUTRAL, SPSN	TRIPLE POLE, TP	TRIPLE POLE AND BOLTED NEUTRAL, TPN	TRIPLE POLE AND SWITCHED NEUTRAL, TPSN
1	32A	32A	32A	32A	BS A1	32S1N32	32S1SN32	32S332	32S3N32	32S3SN32
1	63A	63A	63A	63A	BS A2	63S1N63	63S1SN63	63S363	63S3N63	63S3SN63
2	63A	63A	63A	45A	BS A3	63S1N45	63S1SN45	63S345	63S3N45	63S3SN45
2	100A	100A	100A	63A	BS A3	100S1N63	100S1SN63	100S363	100S3N63	100S3SN63
2	100A	100A	100A	100A	BS A3	100S1N100	100S1SN100	100S3100	100S3N100	100S3SN100
3	125A	125A	125A	125A	BS A4	125S1N125	125S1SN125	125S3125	125S3N125	125S3SN125
3	160A	200A	200A	160A	BS A4	200S1N160	200S1SN160	200S3160	200S3N160	200S3SN160
4	200A	200A	200A	200A	BS B2	200S1N200	200S1SN200	200S3200	200S3N200	200S3SN200
4a	220A	250A	250A	250A	BS B3			250S3250	250S3N250	250S3SN250
4b	315A	315A	315A	315A	BS B4			315S3315	315S3N315	315S3SN315
5	400A	400A	400A	400A	BS B4			400S3400	400S3N400	400S3SN400
6	630A	630A	630A	630A	BS C3			630S3630	630S3N630	630S3SN630
6	800A	800A	800A	710A	BS C3			800S3710	800S3N710	800S3SN710



BS Fuse Version - Side Operation

FRAME SIZE	ENCLOSED RATING I _{th}	OPEN RATING I _{th}	AC22	AC23	MEM FUSE	TRIPLE POLE TP	TRIPLE POLE AND BOLTED NEUTRAL, TPN	TRIPLE POLE AND SWITCHED NEUTRAL, TPSN
1	32A	32A	32A	32A	BS A1	32SM332	32SM3N32	32SM3SN32
1	63A	63A	63A	63A	BS A2	63SM363	63SM3N63	63SM3SN63
2	63A	63A	63A	45A	BS A3	63SM345	63SM3N45	63SM3SN45
2	100A	100A	100A	63A	BS A3	100SM363	100SM3N63	100SM3SN63
2	100A	100A	100A	100A	BS A3	100SM3100	100SM3N100	100SM3SN100
3	125A	125A	125A	125A	BS A4	125SM3125	125SM3N125	125SM3SN125
3	160A	200A	200A	160A	BS A4	200SM3160	200SM3N160	200SM3SN160



Switch-Disconnecter - Standard Operation

FRAME SIZE	ENCLOSED RATING I _{th}	OPEN RATING I _{th}	AC22	AC23	DOUBLE POLE, DP	TRIPLE POLE TP	FOUR POLE FP
1	45A	45A	45A	32A	IS452	IS453	IS454
2	100A	100A	100A	63A	IS1002	IS1003	IS1004
3	160A	160A	160A	125A	IS1602	IS1603	IS1604
4	315A	315A	315A	250A		IS3153	IS3154
5	630A	630A	630A	400A		IS6003	IS6004
6	1000A	1000A	1000A	710A		IS10003	IS10004



550V ratings



PANEL MOUNTING SWITCHGEAR

FUSED COMBINATION SWITCHES ORDER REFERENCES

ORDER REFERENCES

BS Fuse Version - Changeover Switches



FRAME SIZE	ENCLOSED RATING I _{th}	OPEN RATING I _{th}	AC22	AC23	MEM FUSE	TRIPLE POLE, TP		TRIPLE POLE AND BOLTED NEUTRAL, TPN		TRIPLE POLE AND SWITCHED NEUTRAL, TPSN	
						LIST NO.	LIST NO.	LIST NO.	LIST NO.	LIST NO.	
1 1	32A 63A	32A 63A	32A 63A	32A 63A	BS A1 BS A2	32SC332 63SC363	32SC3N32 63SC3N63	32SC3SN32 63SC3SN63			
2 2 2	63A 100A 100A	63A 100A 100A	63A 100A 100A	45A 63A 100A	BS A3 BS A3 BS A3	63SC345 100SC363 100SC3100	63SC3N45 100SC3N63 100SC3N100	63SC3SN45 100SC3SN63 100SC3SN100			
3 3	125A 160A	125A 200A	125A 200A	125A 160A	BS A4 BS A4	125SC3125 200SC3160	125SC3N125 200SC3N160	125SC3SN125 200SC3SN160			
4 4a 4b 4b	200A 220A 315A 345A	200A 250A 315A 400A	200A 250A 315A 400A	200A 250A 315A 400A	BS B2 BS B3 BS B4 BS B4	200SC3200 250SC3250 315SC3315 400SC3400	200SC3N200 250SC3N250 315SC3N315 400SC3N400	200SC3SN200 250SC3SN250 315SC3SN315 400SC3SN400			

BS Fuse Version - Standard Operation Test Switches



FRAME SIZE	ENCLOSED RATING I _{th}	OPEN RATING I _{th}	AC22	AC23	MEM FUSE	TRIPLE POLE, TP		TRIPLE POLE AND BOLTED NEUTRAL, TPN		TRIPLE POLE AND SWITCHED NEUTRAL, TPSN	
						LIST NO.	LIST NO.	LIST NO.	LIST NO.	LIST NO.	
1 1	32A 63A	32A 63A	32A 63A	32A 63A	BS A1 BS A2	32ST332 63ST363	32ST3N32 63ST3N63	32ST3SN32 63ST3SN63			
2 2 2	63A 100A 100A	63A 100A 100A	63A 100A 100A	45A 63A 100A	BS A3 BS A3 BS A3	63ST345 100ST363 100ST3100	63ST3N45 100ST3N63 100ST3N100	63ST3SN45 100ST3SN63 100ST3SN100			
3 3	125A 160A	125A 200A	125A 200A	125A 160A	BS A4 BS B2	125ST3125 200ST3160	125ST3N125 200ST3N160	125ST3SN125 200ST3SN160			
4 4a 4b 4b	200A 220A 315A 345A	200A 250A 315A 400A	200A 250A 315A 400A	200A 250A 315A 400A	BS B2 BS B3 BS B4 BS B4	200ST3200 250ST3200 315ST3315 400ST3400	200ST3N200 250ST3N200 315ST3N315 400ST3N400	200ST3SN200 250ST3SN200 315ST3SN315 400ST3SN400			

DIN Fuse Version - Standard Operation



FRAME SIZE	ENCLOSED RATING I _{th}	OPEN RATING I _{th}	AC22	AC23	FUSE	TRIPLE POLE, TP		TRIPLE POLE AND SWITCHED NEUTRAL, TPN		FOUR POLE FP	
						LIST NO.	LIST NO.	LIST NO.	LIST NO.	LIST NO.	
1a	63A	63A	63A	63A	000 / C00	DS63-000	DS63SN-000	DS63FP-000			
2a 2a	100A 115A	100A 125A	100A 125A	100A 125A	'00 '00	DS100-00 DS125-00	DS100SN-00 DS125SN-00	DS100FP-00 DS125FP-00			
3	135A	160A	160A	160A	'00	DS160-00	DS160SN-00	DS160FP-00			
4a 4b 4b	220A 315A 345A	250A 315A 400A	250A 315A 400A	250A 315A 400A	'1 '2 '2	DS250-1 DS315-2 DS400-2	DS250SN-1 DS315SN-2 DS400SN-2	DS250FP-1 DS315FP-2 DS400FP-2			
5a	540A	630A	630A	630A	'3	DS630-3	DS630SN-3	DS630FP-3			

TERMINATION INFORMATION

ORDER REFERENCES

DIN Fuse Version - Side Operation

FRAME SIZE	ENCLOSED RATING I _{th}	OPEN RATING I _{th}	AC22	AC23	FUSE	TRIPLE POLE, TP LIST NO.	TRIPLE POLE AND SWITCHED NEUTRAL, TPSN LIST NO.	FOUR POLE, FP LIST NO.
1a	63A	63A	63A	63A	000 / C00	SMDS63-000	SMDS63SN-000	SMDS63FP-000
2a	100A	100A	100A	100A	'00	SMDS100-00	SMDS100SN-00	SMDS100FP-00
2a	115A	125A	125A	125A	'00	SMDS125-00	SMDS125SN-00	SMDS125FP-00
3	135A	160A	160A	160A	'00	SMDS160-00	SMDS160SN-00	SMDS160FP-00



TERMINATION INFORMATION

FRAME SIZE	SWITCH RANGE 'BS'	DIN	NFC	ISOLATOR	TERMINAL SIZE		TERMINATION TORQUE NM		MAX CABLE SQ _{mm}	MAXCONNECTOR SIZE	
					'BS' FUSE	SUPPLY/LOAD	'BS' FUSE	SUPPLY/LOAD		DIM T mm	DIM U mm
1	32A/32A, 63A/63A	-	25A	45A	M4	M5	1.2	3	25	-	-
1a	-	63A	50A	-	M4	M5	1.2	3	25	-	-
2	100A/63A, 100A/100A	-	-	100A	M5	M6	2	5	35	10	19
2a	-	100A, 125A	100A	-	-	M6	-	5	35	10	19
3	125A/125A, 200A/160A	160A	-	160A	M5/M6	M8	2.0/4.0	12	70	12	23
4	200A/200A	-	-	315A	M8	M10	10	25	150	22	32
4a	250A/250A	250A	-	-	M8	M10	10	25	150	22	32
4b	315A/315A, 400A/400A	315A, 400A	-	-	M8	M10	10	25	240	22	40
5	400A/400A	-	-	630A	M8	M14	10	50	500	22	58
5a	-	630A	-	-	-	M14	-	50	500	22	58
6	630A/500A, 630A/630A	-	-	1000A	M10	M16	21	60	630	26	70
6	800A/710A	-	-	-	M10	M20	21	100	630	40	70
Auxiliary Switches - ASP to 8ASP					-	M3	-	5	2.5	-	-

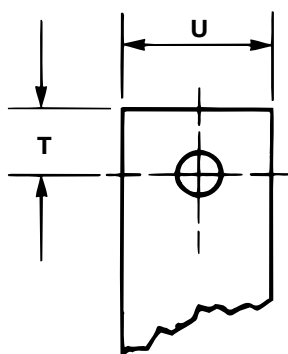

PANEL MOUNTING SWITCHGEAR

FUSED COMBINATION SWITCHES

TECHNICAL INFORMATION – BS & DIN

The technical information given in this table applies to 3 and 4 pole fused combination switches

				32A/32A BS	63A/63A BS	100A/63A BS	100A/100A BS	125A/125A BS	200A/160A BS
Frame size				1	1	2	2	3	3
Fused combination switch, nominal rating			A	32	63	100	100	125	200
Rated thermal current (ambient -5°C to +40°C)	unenclosed	Ith	A	32	63	100	100	125	200
	enclosed	Ithe	A	32	63	63	100	125	160
	enclosed with solid links	Ithe	A	45	63	100	100	160	200
Category of duty AC22A		Ue		Ie	Ie	Ie	Ie	Ie	Ie
Rated operational current		415V	A	32	63	100	100	125	200
		500V	A	32	63	100	100	125	160
		550V	A	32	63	100	100	125	135
Category of duty AC23A		Ue		Ie	Ie	Ie	Ie	Ie	Ie
Rated operational current		220V	A	32	63	63	100	125	160
		380V	A	32	63	63	100	125	160
		415V	A	32	63	63	100	125	160
		500V	A	32	63	63	100	125	160
		550V	A	32	63	63	100	125	135
		690V	A	-	-	-	-	-	-
Rated operational current DC23	Single pole	110V	A	32	63	63	100	125	125
Rated operational current	two poles in series	250V	A	32	63	63	100	125	125
	two poles in series	500V	A	32	63	63	100	80	80
Rated operational power for category AC23A		Ue							
		220V	kW	7.5	15	15	30	37	45
		380V	kW	15	30	30	45	55	75
		415V	kW	15	30	30	55	60	90
		500V	kW	20	37	37	60	75	90
		550V	kW	22	45	45	75	90	90
		690V	kW	-	-	-	-	-	-
Rated operational performance	Number of cycles			10,000	10,000	10,000	10,000	8,000	8,000
		Ue							
Short-time withstand current for 1 second	RMS value	-	kA	1.39	1.5	3.2	3.2	5	5
Short-circuit making capacity	Peak-value	550V	kA	3.06	3.7	4.25	4.25	5.44	5.44
Fuse protected performance		Ue							
	RMS value	415V	kA	80	100	80	80	80	80
		500V	kA	63	100	63	63	63	63
		550V	kA	63	100	63	63	63	63
		690V	kA	-	-	-	-	-	-
	Peak-value	415V	kA	176	220	176	176	176	176
		500V	kA	139	220	139	139	139	139
		550V	kA	139	220	139	139	139	139
		550V	kA	139	220	139	139	139	139
690V		kA	-	-	-	-	-	-	
Rated operational voltage	Ue	V	550	550	550	550	550	550	
Rated insulation voltage (2)	Ui	V	690	690	690	690	690	690	
Rated impulse voltage	Uimp	kV	8	8	8	8	8	8	
Rated capacitor power (1)		kVAr	24	45	45	55	90	120	
Fuse types, BS-pattern	BS88			A1	SB3/4	A2-A3	A2-A3	A2-A3	A2-A4
	Fuse fixing centres		mm	44.5	73	73	73	73,94	73,94
NFC-pattern				-	-	-	-	-	-
DIN-pattern	DIN43620			-	-	-	-	-	-
Solid copper links				20MLK	63MLK	63MLK	63MLK	100MLK	100MLK
Weight (cartoned) not including fuselinks	SPN,SPSN		kg	0.9	0.92	1.36	1.36	1.6	1.7
	DP		kg	0.9	0.92	1.36	1.36	1.9	2
	TP		kg	1.04	1.12	1.57	1.57	2.51	2.58
	TPSN		kg	1.2	1.25	1.81	1.81	2.78	2.96
	FP		kg	-	-	-	-	-	-

(1) The Capacitor rating of the switch is limited by the fuselink

(2) Units with a rated insulation voltage at 1000V are available to special order

200A/200A BS	250A/250A BS	315A/315A BS	400A/400A BS	400A/400A BS	630A/630A BS	800A/710A BS	63A DIN	100A DIN	125A DIN	160A DIN	250A DIN	315A DIN	400A DIN	630A DIN
4	4a	4b	4b	5	6	6	1a	2a	2a	3	4a	4b	4b	5a
200	250	315	400	400	630	800	63	100	125	160	250	315	400	630
200	250	315	400	400	630	800	63	100	125	160	250	315	400	630
200	250	315	345	400	630	710	63	100	115	135	250	315	345	540
315	315	315	400	400	630	800	-	-	-	-	-	-	-	-
Ie	Ie	Ie	Ie	Ie	Ie	Ie	Ie	Ie	Ie	Ie	Ie	Ie	Ie	Ie
200	250	315	400	400	630	800	63	100	125	160	250	315	400	630
200	250	315	400	400	-	-	63	100	125	160	250	315	400	630
200	250	315	400	400	-	-	63	100	115	135	250	315	315	540
Ie	Ie	Ie	Ie	Ie	Ie	Ie	Ie	Ie	Ie	Ie	Ie	Ie	Ie	Ie
200	250	315	400	400	630	710	63	100	125	160	250	315	400	630
200	250	315	400	400	630	710	63	100	125	160	250	315	400	630
200	250	315	400	400	630	710	63	100	125	160	250	315	400	630
200	250	315	400	400	-	630	63	100	125	160	250	315	400	630
200	250	315	315	400	-	630	63	100	115	135	250	315	315	540
-	-	-	-	-	-	-	63	100	115	135	250	315	315	540
200	250	315	315	400	630	800	32	100	1	125	200	315	315	400
200	250	315	315	400	630	800	32	100	63	125	200	315	315	400
200	-	-	-	-	-	-	32	100	63	80	200	-	-	-
55	75	110	132	132	200	220	15	30	37	45	75	110	132	200
110	130	150	185	185	315	355	30	45	55	75	130	150	185	315
110	130	150	225	225	375	410	30	55	60	90	130	150	225	375
130	150	185	225	280	-	475	37	60	75	90	150	185	225	375
150	185	225	225	300	-	515	45	75	75	90	185	225	225	400
-	-	-	-	-	-	-	45	90	90	110	225	290	290	500
8,000	8,000	8,000	5,000	5,000	5,000	3,000	10,000	10,000	8,000	8,000	8,000	8,000	5,000	5,000
10	10	10	10	10	10	10	1.5	3.2	3.2	5	10.96	10.96	10.96	12.96
10.7	10.7	10.7	10.7	10.7	10.7	10.7	3.7	4.25	4.25	5.44	10.81	10.81	10.81	25.2
100	100	72.5	72.5	80	50	50	100	100	100	100	100	72.5	72.5	50
100	100	72.5	72.5	63	-	50	100	100	100	100	100	72.5	72.5	50
100	100	50	50	63	-	50	100	100	100	100	100	50	50	50
-	-	-	-	-	-	-	100	100	100	100	100	50	50	50
220	220	160	160	176	110	110	220	220	220	220	220	160	160	110
139	220	160	160	176	-	110	220	220	220	220	220	160	160	110
139	220	105	105	139	-	110	220	220	220	220	220	110	110	110
-	-	-	-	-	-	-	220	220	220	220	220	110	110	110
550	550	550	550	550	415	550	550	550	550	550	550	550	550	550
690	690	690	690	690	690	690	690	690	690	690	690	690	690	690
8	8	8	8	8	8	8	8	8	8	8	8	8	8	8
140	140	160	200	200	270	370	45	45	45	90	140	140	140	200
B1-B2	B1-B2	B1-B4	B1-B4	B1-B4	C1-C3	C1-C3	-	-	-	-	-	-	-	-
111	111	111	111	111	133,184	133,184	-	-	-	-	-	-	-	-
-	-	-	-	-	-	-	-	-	-	-	-	-	-	-
-	-	-	-	-	-	-	000/C00	0	0	0	1	2	2	3
200MLK	200MLK	400MLK	400MLK	400MLK	800MLK	800MLK	-	-	-	-	-	-	-	-
5.63	-	-	-	-	-	-	-	-	-	-	-	-	-	-
5.63	-	-	-	-	-	-	-	-	-	-	-	-	-	-
6.7	6.77	8	8	18.5	-	38	1.12	1.57	1.57	2.5	6.77	8	8	18.5
7.5	7.75	9	9	19.5	-	41	1.25	1.81	1.81	2.6	7.75	9	9	19.5
-	-	-	-	-	-	-	1.3	1.85	1.85	2.9	7.9	9.2	9.2	20.5



PANEL MOUNTING SWITCHGEAR

FUSED COMBINATION SWITCHES ACCESSORIES AND OPTIONS

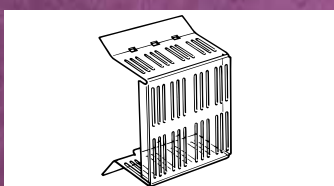
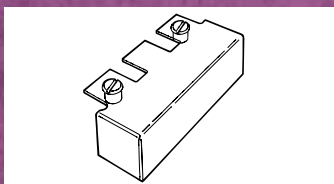
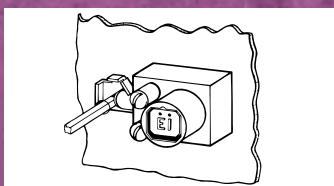
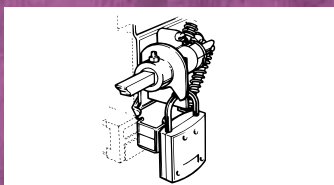
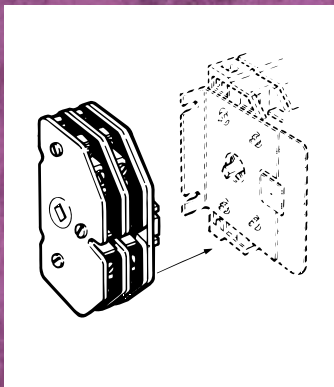
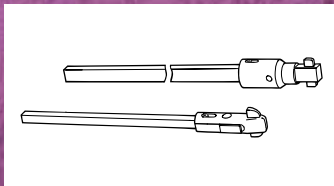
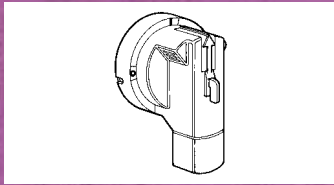

HANDLES

Red/yellow safety handles (IP54) suitable for up to three padlocks in the 'OFF' position.

IP65 HANDLES

Alternative handles are available for standard and test switches. (Non defeatable for ON/OFF action, non interlocked in test position for 'ON-OFF-TEST' action). Details on request.

These handles require special IP65 shafts/adaptors.

EXTENDED HANDLE SHAFTS

Operating shafts of extra 200mm length.

AUXILIARY SWITCHES

List no. ASP contains 2 N/O contacts. List no. 1ASP to 8ASP each contain two sets of changeover contacts. These moulded units have been designed to offer protection against accidental finger contact.

Auxiliary packs can be added to the drive shaft of any switch rating via the appropriate mounting pack adaptor.

Technical Data, Ith=10A:

Ue	ACII	DCII
48V	10A	-
110V	10A	-
220/240V	6A	-
380/440V	4A	-

CHANGEOVER SWITCHES - AUXILIARIES

Three position (1-0-2) changeover switches are available in TP, TPSN and TPN versions.

Auxiliaries can be added to each operating position.

Please note that an auxiliary switch mounting pack is required for both sides on changeover and test position switches.

LOCKING DEVICES

Standard handles are capable of accepting three padlocks to lock the handle in the 'OFF' position.

MECHANISM PADLOCKING DEVICE

To lock switch in 'OFF' position when enclosure is 'OPEN'.

FIGURE LOCKING DEVICE

To provide locking 'ON', 'OFF' and interlocking facility.

The device is a shaft mounting interlock cam attachment for adaptation to Castell or Fortress figure locks. (Not supplied).

CABLE TERMINAL SHROUDS

Packs of clear polycarbonate shrouds to protect cable terminations from unintentional contact (1 per pack).

A pack of eight push-in plugs List No. ITS4 are available for frame size 1 and 1a which have finger protected main terminals.

FUSE COVERS

Clear polycarbonate clip-on covers to protect all fuses from unintentional contact.

ORDER REFERENCES:
ACCESSORIES FOR BS AND DIN TYPE SWITCHES

Frame size	Poles	Accessory													Figure Locking Device	List No.
		Safety Handles	Extended Shafts	Auxiliary Switch Pack 2 N/O	Auxiliary Switch Pack 1 C/O	Auxiliary Switch Pack 2 C/O	Auxiliary Switch Pack 3 C/O	Auxiliary Switch Pack 4 C/O	Auxiliary Switch Pack 6 C/O	Auxiliary Switch Pack 8 C/O	Auxiliary Switch Mounting Pack	Push in Terminal Plugs	Terminal Shrouds BS Type	Terminal Shrouds DIN Type		
1	SPN	3SHN	3XS	1ASP	2ASP	3ASP	4ASP	-	-	-	1TS4	2TS2	-	1FC2	-	3FLD
	SPSN	3SHN	3XS	1ASP	2ASP	3ASP	4ASP	-	-	-	1TS4	2TS2	-	1FC2	-	3FLD
	TP	3SHN	3XS	1ASP	2ASP	3ASP	4ASP	-	-	-	1TS4	2TS2	-	1FC3	-	3FLD
	TPN	3SHN	3XS	1ASP	2ASP	3ASP	4ASP	-	-	-	1TS4	2TS2	-	1FC4	-	3FLD
	TPSN	3SHN	3XS	1ASP	2ASP	3ASP	4ASP	-	-	-	1TS4	2TS2	-	1FC3	-	3FLD
1a	SPN	3SHN	3XS	1ASP	2ASP	3ASP	4ASP	-	-	-	1TS4	1ATS2	-	N1FC2	-	3FLD
	SPSN	3SHN	3XS	1ASP	2ASP	3ASP	4ASP	-	-	-	1TS4	1ATS2	-	N1FC2	-	3FLD
	TP	3SHN	3XS	1ASP	2ASP	3ASP	4ASP	-	-	-	1TS4	1ATS2	-	N1FC3	D1FC3	3FLD
	TPN	3SHN	3XS	1ASP	2ASP	3ASP	4ASP	-	-	-	1TS4	1ATS4	-	N1FC4	D1FC3	3FLD
	TPSN	3SHN	3XS	1ASP	2ASP	3ASP	4ASP	-	-	-	1TS4	1ATS4	-	N1FC3	D1FC3	3FLD
2	SPN	3SHN	3XS	1ASP	2ASP	3ASP	4ASP	-	-	-	-	2TS2	-	2FC2	-	3FLD
	SPSN	3SHN	3XS	1ASP	2ASP	3ASP	4ASP	-	-	-	2TS2	-	2FC2	-	3FLD	
	TP	3SHN	3XS	1ASP	2ASP	3ASP	4ASP	-	-	-	2TS3	-	2FC3	-	3FLD	
	TPN	3SHN	3XS	1ASP	2ASP	3ASP	4ASP	-	-	-	2TS4	-	2FC4	-	3FLD	
	TPSN	3SHN	3XS	1ASP	2ASP	3ASP	4ASP	-	-	-	2TS4	-	2FC3	-	3FLD	
2a	TP	3SHN	3XS	1ASP	2ASP	3ASP	4ASP	-	-	-	-	D2TS3	-	D2FC3	-	3FLD
	TPSN	3SHN	3XS	1ASP	2ASP	3ASP	4ASP	-	-	-	D2TS4	-	D2FC3	-	3FLD	
	FP	3SHN	3XS	1ASP	2ASP	3ASP	4ASP	-	-	-	D2TS4	-	D2FC4	-	3FLD	
3	SPN	3SHN	3XS	1ASP	2ASP	3ASP	4ASP	-	-	-	-	3TS2	-	3FC2/D3FC2*	-	3FLD
	SPSN	3SHN	3XS	1ASP	2ASP	3ASP	4ASP	-	-	-	3TS2	-	3FC2/D3FC2*	-	3FLD	
	TP	3SHN	3XS	1ASP	2ASP	3ASP	4ASP	-	-	-	3TS3	-	3FC3/D3FC3*	D3FC3	3FLD	
	TPN	3SHN	3XS	1ASP	2ASP	3ASP	4ASP	-	-	-	3TS4	-	3FC4/D3FC4*	-	3FLD	
	TPSN	3SHN	3XS	1ASP	2ASP	3ASP	4ASP	-	-	-	3TS4	-	3FC3/D3FC3*	D3FC4	3FLD	
4	SPN	4SHN	4XS	1ASP	2ASP	3ASP	4ASP	-	-	-	-	4TS2	-	4FC2	-	4PLD
	SPSN	4SHN	4XS	1ASP	2ASP	3ASP	4ASP	-	-	-	4TS2	-	4FC2	-	4PLD	
	TP	4SHN	4XS	1ASP	2ASP	3ASP	4ASP	-	-	-	4TS3	-	4FC3	-	4PLD	
	TPN	4SHN	4XS	1ASP	2ASP	3ASP	4ASP	-	-	-	4TS4	-	4FC4	-	4PLD	
	TPSN	4SHN	4XS	1ASP	2ASP	3ASP	4ASP	-	-	-	4TS4	-	4FC3	-	4PLD	
4a	TP	4SHN	4XS	1ASP	2ASP	3ASP	4ASP	-	-	-	-	D4TS3	-	4FC3E	D3FC3	4PLD
	TPN	4SHN	4XS	1ASP	2ASP	3ASP	4ASP	-	-	-	D4TS4	-	4FC4E	D4FC3	4PLD	
	TPSN	4SHN	4XS	1ASP	2ASP	3ASP	4ASP	-	-	-	D4TS4	-	4FC3E	D4FC3	4PLD	
	FP	4SHN	4XS	1ASP	2ASP	3ASP	4ASP	-	-	-	D4TS4	-	4FC4E	D4FC4	4PLD	
	FP	4SHN	4XS	1ASP	2ASP	3ASP	4ASP	-	-	-	D4TS4	-	4FC3E	D4FC4	4PLD	
4b	TP	4SHN	4XS	1ASP	2ASP	3ASP	4ASP	-	-	-	-	D4TS3E	-	D4FC3E	D4FC3E	4PLD
	TPN	4SHN	4XS	1ASP	2ASP	3ASP	4ASP	-	-	-	D4TS4E	-	D4FC4E	D4FC4E	4PLD	
	TPSN	4SHN	4XS	1ASP	2ASP	3ASP	4ASP	-	-	-	D4TS4E	-	D4FC3E	D4FC3E	4PLD	
	FP	4SHN	4XS	1ASP	2ASP	3ASP	4ASP	-	-	-	D4TS4E	-	D4FC4E	D4FC4E	4PLD	
	FP	4SHN	4XS	1ASP	2ASP	3ASP	4ASP	-	-	-	D4TS4E	-	D4FC3E	D4FC4E	4PLD	
5	TP	5SHN	6XS	1ASP	2ASP	3ASP	4ASP	-	-	-	-	5TS3	-	5FC3	-	6PLD
	TPN	5SHN	6XS	1ASP	2ASP	3ASP	4ASP	-	-	-	5TS4	-	5FC4	-	6PLD	
	TPSN	5SHN	6XS	1ASP	2ASP	3ASP	4ASP	-	-	-	5TS4	-	5FC3	-	6PLD	
	FP	5SHN	6XS	1ASP	2ASP	3ASP	4ASP	-	-	-	-	D5TS3	-	D5FC3	-	6PLD
	FP	5SHN	6XS	1ASP	2ASP	3ASP	4ASP	-	-	-	D5TS4	-	D5FC4	-	6PLD	
5a	TP	5SHN	6XS	1ASP	2ASP	3ASP	4ASP	-	-	-	-	D5TS3	-	D5FC3	-	6PLD
	TPSN	5SHN	6XS	1ASP	2ASP	3ASP	4ASP	-	-	-	D5TS4	-	D5FC4	-	6PLD	
	FP	5SHN	6XS	1ASP	2ASP	3ASP	4ASP	-	-	-	-	D5TS4	-	D5FC3	-	6PLD
	FP	5SHN	6XS	1ASP	2ASP	3ASP	4ASP	-	-	-	-	D5TS4	-	D5FC4	-	6PLD
	FP	5SHN	6XS	1ASP	2ASP	3ASP	4ASP	-	-	-	-	D5TS4	-	D5FC3	-	6PLD
6	TP	6SHN	6XS	1ASP	2ASP	3ASP	4ASP	-	-	-	-	6TS4	-	6FC3	-	6PLD
	TPN	6SHN	6XS	1ASP	2ASP	3ASP	4ASP	-	-	-	6TS4	-	6FC4	-	6PLD	
	TPSN	6SHN	6XS	1ASP	2ASP	3ASP	4ASP	-	-	-	6TS4	-	6FC3	-	6PLD	
	FP	6SHN	6XS	1ASP	2ASP	3ASP	4ASP	-	-	-	-	6TS4	-	6FC4	-	6PLD
	FP	6SHN	6XS	1ASP	2ASP	3ASP	4ASP	-	-	-	-	6TS4	-	6FC3	-	6PLD

* Fuse covers for BS Type units I60200A.
** Suitable padlock: List No. PD4



BS SIDE MECHANISM FUSED COMBINATION SWITCHES

Frame Size	List Number	A (mm)	A2 (mm)	B1 (mm)	B2 (mm)	B3 (mm)	C1 (mm)	C2 (mm)	C3 (mm)	D (mm)	E (mm)	F1 (mm)	G1 (mm)	H1 (mm)	J1 (mm)	J2 (mm)	K (mm)	L (mm)	M (mm)	N (mm)	P (mm)	Q (mm)	R (mm)	S (mm)	T (mm)	U1 (mm)	U2 (mm)	W1 (mm)	W2 (mm)	X (mm)	Y (mm)	Z1 (mm)	Z2 (mm)
1	32SM332 32SM3N32, 32SM3SN32	21.5	45	91	93	31	98	126	-	83.5	88.5 109.5	56	-	16.7	34.5	20	21	81.5	65	5.5	-	-	121	13	14	78	83	6	8	6.3 SQ	55	38	-
1	63SM363 63SM3N63, 63SM3SN63	21.5	45	91	93	31	98	126	-	83.5	88.5 109.5	56	-	16.7	34.5	20	21	81.5	65	5.5	-	-	121	13	14	78	83	6	8	6.3 SQ	55	38	-
2	63SM345 63SM3N45, 63SM3SN45	21	45	107	109	36.5	107	145	166	95	119.5 150.5	72	27	25.5	38.5	26.5	31	95.5	65	5.5	18	6	125	15	19	94	99	6.7	7.5	6.3 SQ	55	45	47
2	100SM363 100SM3N63, 100SM3SN63	21	45	107	109	36.5	107	145	166	95	119.5 150.5	72	27	25.5	38.5	26.5	31	95.5	65	5.5	18	6	125	15	19	94	99	6.7	7.5	6.3 SQ	55	45	47
2	100SM3100 100SM3N100, 100SM3SN100	21	45	107	109	36.5	107	145	166	95	119.5 150.5	72	27	25.5	38.5	26.5	31	95.5	65	5.5	18	6	125	15	19	94	99	6.7	7.5	6.3 SQ	55	45	47
3	125SM3125 125SM3N125, 125SM3SN125	21	45	124	135.5	36.5	142	181	209.5	120.5	144.5 184.5	80	23	21	43	30.5	40	123.5	65	5.5	22	8	125	15	19.5	120	125.5	7.5	9	6.3 SQ	55	45	47
3	200SM3160 200SM3N160, 200SM3SN160	21	45	137.5	139.5	36.5	142	181	209.5	120.5	144.5 184.5	80	23	21	43	30.5	40	123.5	65	5.5	22	8	125	15	19.5	120	114	7.5	9	6.3 SQ	55	39	47

DIN SIDE MECHANISM FUSED COMBINATION SWITCHES

Frame Size	List Number	A (mm)	A2 (mm)	B1 (mm)	B2 (mm)	B3 (mm)	C1 (mm)	C2 (mm)	C3 (mm)	D (mm)	E (mm)	F1 (mm)	G1 (mm)	H1 (mm)	J1 (mm)	J2 (mm)	K (mm)	L (mm)	M (mm)	N (mm)	P (mm)	Q (mm)	R (mm)	S (mm)	T (mm)	U1 (mm)	U2 (mm)	W1 (mm)	W2 (mm)	X (mm)	Y (mm)	Z1 (mm)	Z2 (mm)
1	SMDS63-000 SMDS6363SN-000 SMDS6363FP-000	21.5	45	124.5	126.5	31	98	-	-	83.5	112 139 139	56	-	16.7	34.5	28	26.5	81.5	65	5.5	-	-	121	13	-	88	85	6	8	6.3 SQ	55	-	-
2	SMDS100-00 SMDS100SN-00 SMDS100FP-00	21	45	143.5	145.5	36.5	107	145	176	95	143.5 180.5 180.5	72	27	25.5	38.5	34	36.5	95.5	65	5.5	18	6	125	15	19	95	90	6.7	7.5	6.3 SQ	55	45	47
2a	SMDS125-00 SMDS125SN-00 SMDS125FP-00	21	45	143.5	145.5	36.5	107	145	176	95	143.5 180.5 180.5	72	27	25.5	38.5	34	36.5	95.5	65	5.5	18	6	125	15	19	95	90	6.7	7.5	6.3 SQ	55	45	47
3	SMDS160-00 SMDS160SN-00 SMDS160FP-00	21	45	137.5	139.5	36.5	142	181	209.5	120.5	144.5 184.5 184.5	80	23	21	43	30.5	40	123.5	65	5.5	22	8	125	15	19.5	120	114	7.5	9	6.3 SQ	55	39	47

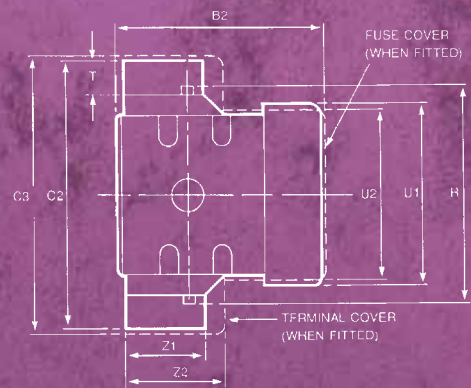
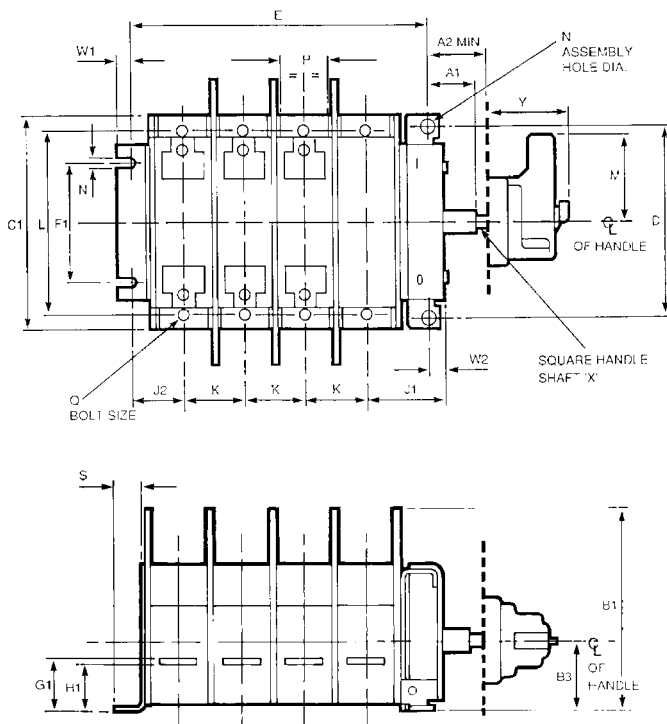

- Note: 1) 'R' = Dimension represents the maximum width across mechanism spring guides.
 2) 'T' = Additional height of connecting barrier.
 3) First auxiliary pack adds 24.5mm to side of the switch when attached. Each additional auxiliary pack adds a further 10.5mm.

PANEL MOUNTING SWITCHGEAR FUSED COMBINATION SWITCHES DIMENSIONS

BS CHANGEOVER FUSED COMBINATION SWITCHES

Frame Size	List Number	A (mm)	B1 (mm)	B2 (mm)	B3 (mm)	C1 (mm)	C2 (mm)	C3 (mm)	E (mm)	F1 (mm)	G1 (mm)	H1 (mm)	HR (mm)	J1 (mm)	J2 (mm)	K (mm)	L (mm)	M (mm)	N (mm)	P (mm)	Q (mm)	R (mm)	S (mm)	T (mm)	U1 (mm)	U2 (mm)	W1 (mm)	X (mm)	Y (mm)	Z1 (mm)	Z2 (mm)	
1	32SC332	203							191	56	-	16.7	175	33.5	20	21	81.5	65	5.5	-	-	121	13	14	78	83	6	6.3	SQ	55	38	-
	32SC3N32	245	91	93	81	98	126	-	233																							
	32SC3SN32	245							233																							
1	63SC363	203							191	56	-	16.7	175	33.5	20	21	81.5	65	5.5	-	-	121	13	14	78	83	6	6.3	SQ	55	38	-
	63SC3N63	245	91	93	81	98	126	-	233																							
	63SC3SN63	245							233																							
2	63SC345	265.5							252	72	27	25.5	175	37.5	26.5	31	95.5	65	5.5	18	6	125	15	19	94	99	6.7	6.3	SQ	55	45	47
	663SC3N45	327.5	107	109	86	107	145	166	314																							
	63SC3SN45	327.5							314																							
2	100SC363	265.5							252	72	27	25.5	175	37.5	26.5	31	95.5	65	5.5	18	6	125	15	19	94	99	6.7	6.3	SQ	55	45	47
	100SC3N63	327.5	107	109	86	107	145	166	314																							
	100SC3SN63	327.5							314																							
2	100SC3100	265.5							252	72	27	25.5	175	37.5	26.5	31	95.5	65	5.5	18	6	125	15	19	94	99	6.7	6.3	SQ	55	45	47
	100SC3N100	327.5	107	109	86	107	145	166	314																							
	100SC3SN100	327.5							314																							
3	125SC3125	320							305	80	23	21	175	42	30.5	40	123.5	65	5.5	22	8	125	15	19.5	120	125.5	7.5	6.3	SQ	55	45	47
	125SC3N125	400	124	135.5	86	142	181	209.5	385																							
	125SC3SN125	400							385																							
3	200SC3160	320							305	80	23	21	175	42	30.5	40	123.5	65	5.5	22	8	125	15	19.5	120	114	7.5	6.3	SQ	55	39	47
	200SC3N160	400	137.5	139.5	86	142	181	209.5	385																							
	200SC3SN160	400							385																							
4	200SC3200	402							382	120	34	31.5	250	63.5	37.5	45	167	130	6.5	32	10	266	22	45	154	159	10	9.5	SQ	55	57	69
	200SC3N200	492	168	190	141	196	286	297	472																							
	200SC3SN200	492							472																							
4a	250SC3250	501							481	120	34	31.5	250	74.3	50.5	58	167	130	6.5	32	10	266	22	61.5	160	157	10	9.5	SQ	55	68	70
	250SC3N250	602	168.5	170.5	141	196	319	324	582																							
	250SC3SN250	602							582																							
4b	315SC3315	567							547	120	34	31.5	250	79.8	56	69	167	130	6.5	32	10	266	22	61.5	160	157	10	9.5	SQ	55	68	70
	315SC3N315	694	202.5	204.5	141	196	319	324	674																							
	315SC3SN315	694							674																							
4b	400SC3400	567							547	120	34	31.5	250	79.8	56	69	167	130	6.5	32	10	266	22	61.5	160	157	10	9.5	SQ	55	68	70
	400SC3N400	694	202.5	204.5	141	196	319	324	674																							
	400SC3SN400	694							674																							

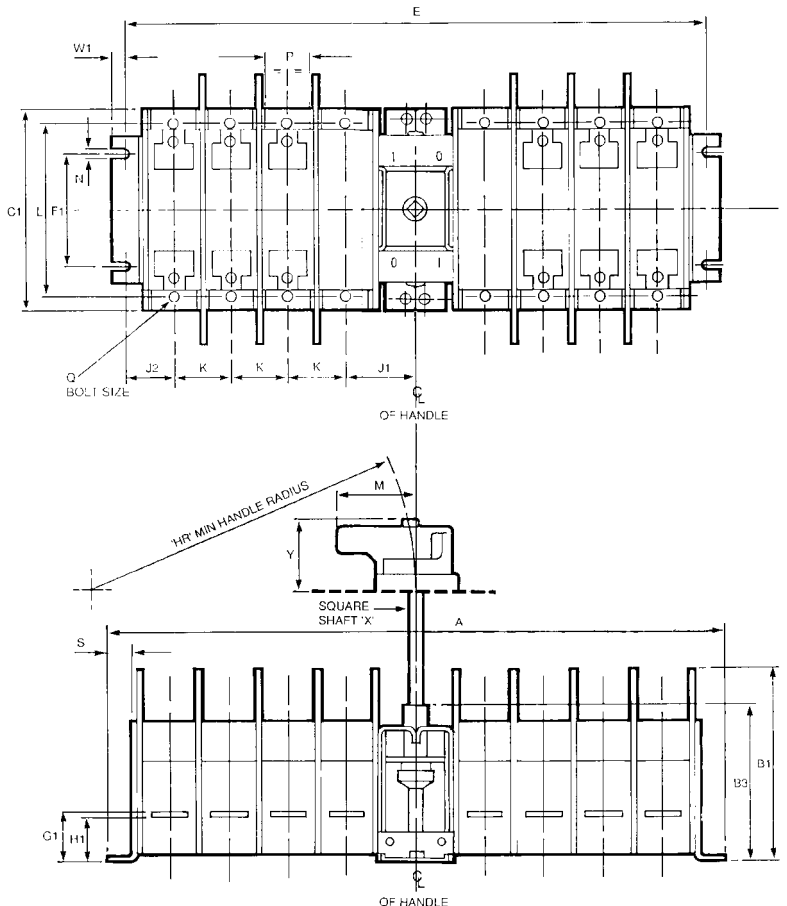
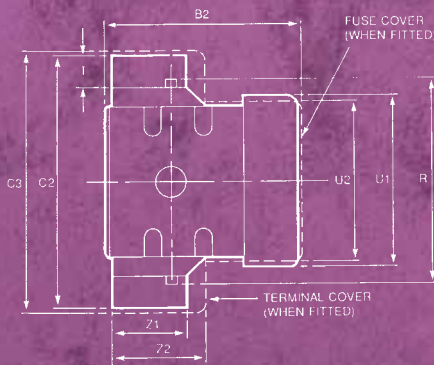

- Note: 1) 'R' = Dimension represents the maximum width across mechanism spring guides.
2) 'T' = Additional height of connecting barrier.
3) First auxiliary pack adds 24.5mm to side of the switch when attached. Each additional auxiliary pack adds a further 10.5mm.

BS TEST POSITION FUSED COMBINATION SWITCHES

Frame Size	List Number	A (mm)	B1 (mm)	B2 (mm)	B3 (mm)	C1 (mm)	C2 (mm)	C3 (mm)	E (mm)	F1 (mm)	G1 (mm)	H1 (mm)	HR (mm)	J1 (mm)	J2 (mm)	K (mm)	L (mm)	M (mm)	N (mm)	P (mm)	Q (mm)	R (mm)	S (mm)	T (mm)	U1 (mm)	U2 (mm)	W1 (mm)	W2 (mm)	W3 (mm)	X (mm)	Y (mm)	Z1 (mm)	Z2 (mm)			
1	32ST332	126							88.5																											
	32ST3N32	146.5	91	93	81	98	126	-	109.5	56	-	16.7	175	33.5	20	21	81.5	65	5.5	-	-	121	13	14	78	83	6	7	25.5	6.3 SQ	55	38	-			
	32ST3SN32	146.5							109.5																											
1	63ST363	126							88.5																											
	63ST3N63	146.5	91	93	81	98	126	-	109.5	56	-	16.7	175	33.5	20	21	81.5	65	5.5	-	-	121	13	14	78	83	6	7	25.5	6.3 SQ	55	38	-			
	63ST3SN63	146.5							109.5																											
2	63ST345	157.5							119.5																											
	63ST3N45	188.5	107	109	86	107	145	166	150.5	72	27	25.5	175	37.5	26.5	31	95.5	65	5.5	18	6	125	15	19	94	99	6.7	6.5	25.5	6.3 SQ	55	45	47			
	63ST3SN45	188.5							150.5																											
2	100ST363	157.5							119.5																											
	100ST3N63	188.5	107	109	86	107	145	166	150.5	72	27	25.5	175	37.5	26.5	31	95.5	65	5.5	18	6	125	15	19	94	99	6.7	6.5	25.5	6.3 SQ	55	45	47			
	100ST3SN63	188.5							150.5																											
2	100ST3100	157.5							119.5																											
	100ST3N100	188.5	107	109	86	107	145	166	150.5	72	27	25.5	175	37.5	26.5	31	95.5	65	5.5	18	6	125	15	19	94	99	6.7	6.5	25.5	6.3 SQ	55	45	47			
	100ST3SN100	188.5							150.5																											
3	125ST3125	185.5							144.5																											
	125ST3N125	225.5	124	135.5	86	142	181	209.5	184.5	80	23	21	175	42	30.5	40	123.5	65	5.5	22	8	125	15	19.5	120	125.5	7.5	8	25.5	6.3 SQ	55	45	47			
	125ST3SN125	225.5							184.5																											
3	200ST3160	188.5							144.5																											
	200ST3N160	225.5	137.5	139.5	86	142	181	209.5	184.5	80	23	21	175	42	30.5	40	123.5	65	5.5	22	8	125	15	19.5	120	114	7.5	8	25.5	6.3 SQ	55	39	47			
	200ST3SN160	225.5							184.5																											
4	200ST3200	251.5							176																											
	200ST3N200	296.5	168	190	141	196	286	297	221	120	34	31.5	250	63.5	37.5	45	167	130	6.5	32	10	266	22	45	154	159	10	15	52	9.5 SQ	55	57	69			
	200ST3SN200	296.5							221																											
4a	250ST3250	302.5							225.5					74.3																						
	250ST3N250	353	168.5	170.5	141	196	319	324	276	120	34	31.5	250	50.5	58	167	130	6.5	32	10	266	22	61.5	160	157	10	15	52	9.5 SQ	55	68	70				
	250ST3SN250	353							276					74.3																						
4b	315ST3315	335.5							258.5					79.8																						
	315ST3N315	399	202.5	204.5	141	196	319	324	322	120	34	31.5	250	56	69	167	130	6.5	32	10	266	22	61.5	160	157	10	15	52	9.5 SQ	55	68	70				
	315ST3SN315	399							322					74.3																						
4b	400ST3400	335.5							258.5					79.8																						
	400ST3N400	399	202.5	204.5	141	196	319	324	322	120	34	31.5	250	56	69	167	130	6.5	32	10	266	22	61.5	160	157	10	15	52	9.5 SQ	55	68	70				
	400ST3SN400	399							322					74.3																						

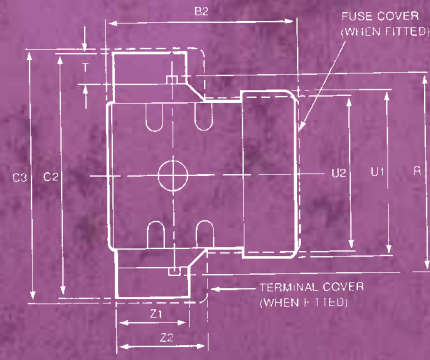
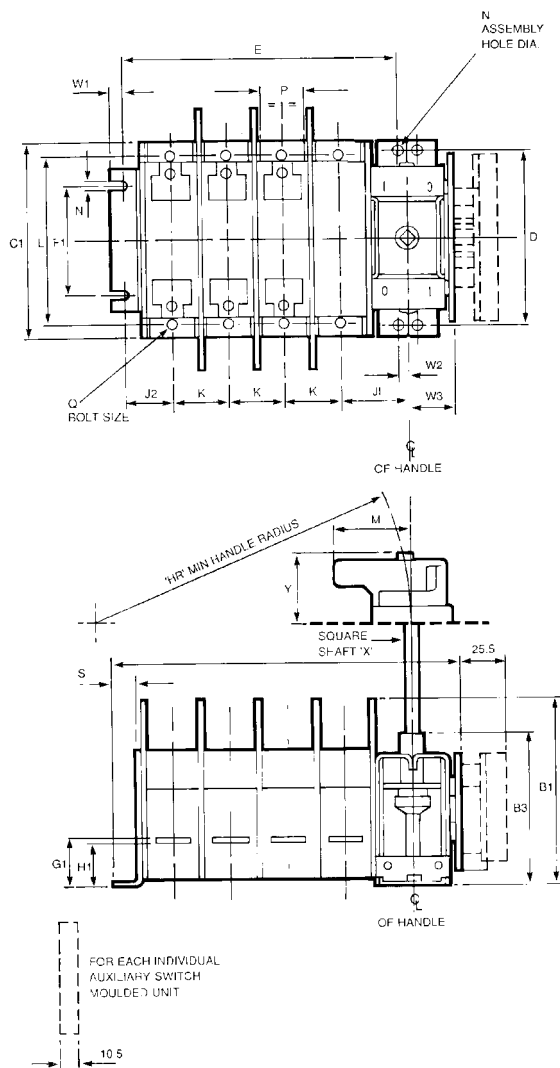

Note: 1) 'R' = Dimension represents the maximum width across mechanism spring guides.
 2) 'T' = Additional height of connecting barrier.
 3) First auxiliary pack adds 24.5mm to side of the switch when attached. Each additional auxiliary pack adds a further 10.5mm.



PANEL MOUNTING SWITCHGEAR FUSED COMBINATION SWITCHES DIMENSIONS

SWITCH – DISCONNECTORS

Frame Size	List Number	A (mm)	B3 (mm)	C1 (mm)	C2 (mm)	C3 (mm)	D (mm)	E (mm)	F1 (mm)	F2 (mm)	G1 (mm)	H1 (mm)	HR (mm)	J1 (mm)	J2 (mm)	K (mm)	L (mm)	M (mm)	N (mm)	P (mm)	Q (mm)	R (mm)	S (mm)	T (mm)	W1 (mm)	W2 (mm)	X (mm)	Y (mm)	Z1 (mm)	Z2 (mm)
1	IS452 IS453 IS454	88.5 109.5 130.5	82	98	126	-	83.5	67.5 88.5 109.5	56	-	-	16.7	175	32.5	20	21	81.5	65	5.5	-	-	121	13	14	6	6	6.3 SQ	55	38	-
2	IS1002 IS1003 IS1004	110 141 172	86	107	145	166	95	88.5 119.5 150.5	72	-	27	25.5	175	36.5	26.5	31	95.5	65	5.5	18	6	125	15	19	6.7	5.5	6.3 SQ	55	45	47
3	IS1602 IS1603 IS1604	129 169 209	86	142	181	209.5	120.5	104.5 144.5 184.5	80	-	23	21	175	41	30.5	40	123.5	65	5.5	22	8	125	15	19.5	7.5	7	6.3 SQ	55	45	47
4	IS3153 IS3154	227 272	141	196	286	297	182.5	176 221	120	-	34	31.5	250	63.5	37.5	45	167	130	6.5	32	10	266	22	45	10	15	9.5 SQ	55	57	69
5	IS6003 IS6004	335 407	165	225	359	365	164	259 331	95	139	43	18	350	64	53.2	72	188	210	8.5	45	14	-	26.5	67	9.5	2.5	14.5 SQ	52	65	83
6	IS10003 IS10004	395 485	183	320	464.5	472.5	164	319.5 411.5	140	180	48.3	32.3	350	74.5	63	92	266.5	214 to 320	8.5	64	20	-	26.5	72	9.5	2	14.5 SQ	60	85	133

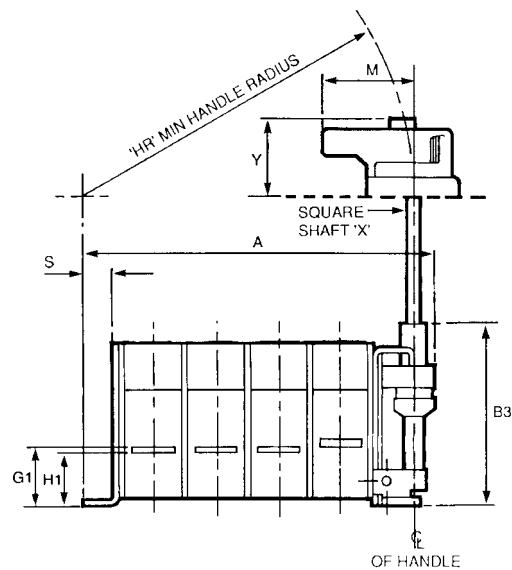
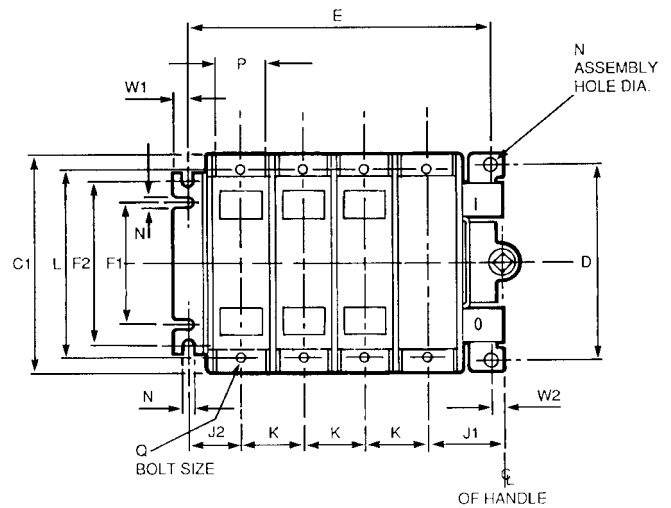
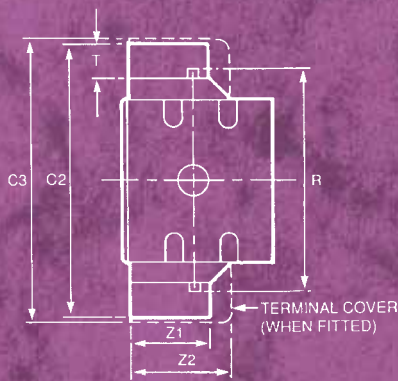

- Note: 1) 'R' = Dimension represents the maximum width across mechanism spring guides.
 2) 'T' = Additional height of connecting barrier.
 3) First auxiliary pack adds 24.5mm to side of the switch when attached. Each additional auxiliary pack adds a further 10.5mm.

HANDLE DIMENSIONS (MM)

FRAME SIZE	FUSED COMBINATION SWITCH RATING, A	SWITCH - DISCONNECTOR RATING, A	A	B	C
1 - 3	32 - 200A	45 - 160A	67	96.5	54
4 - 4b	200 - 400A	200 - 315A	67	159.5	54
5 - 6	400 - 630A	600A	76	245	52.4
6	800A	1000A	90	260/365*	58.9

*Extended length

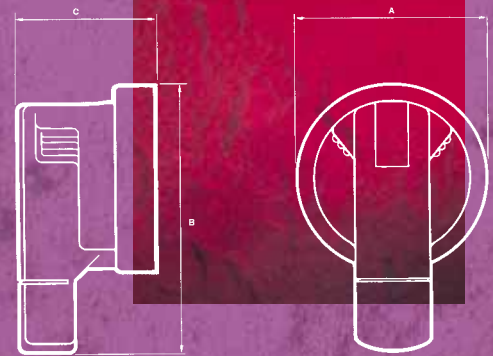

OPERATING HANDLE FIXING APERTURES (DIMENSIONS IN MM)

Handle aligned thus:

Up to 400A

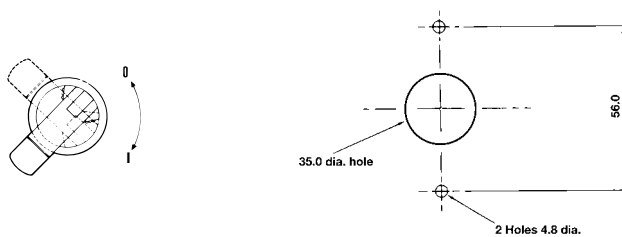

400A - 630A

800A

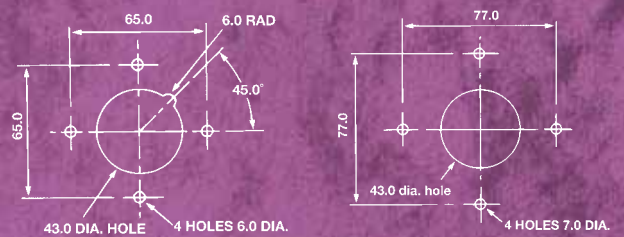

INTERNAL ENCLOSURE DIMENSIONS

These enclosure dimensions are for guidance only as recommended minimum inside enclosure dimensions for temperature rise considerations.

NOTE: Larger dimensions may be necessary for the bending and termination of cables, copper, etc.

FRAME SIZE	SWITCH RATING	A (mm)	B (mm)	C (mm)
1	32A	245	155	215
1	45 - 63A	270	170	275
2	63A	245	155	215
2	100A	270	170	275
3	125A	245	155	215
3	160A	330	220	410
4	200 - 315A	460	290	470
5	400A	460	290	470
6	630 - 710A	670	380	560

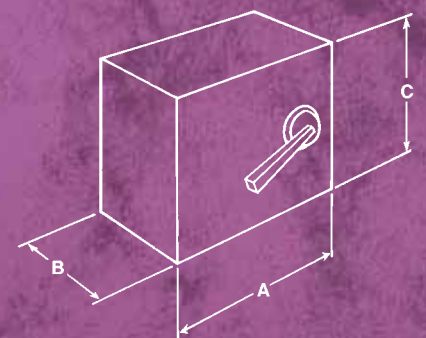

HANDLE OPERATING SHAFT

The cut length of the handle operating shaft must allow a distance of 'A' when the door is firmly closed and any gasket is fully compressed. Dimension 'A'; distance from outside of door to underside of interlock lug, is shown below:-

FRAME SIZE*	1	2	3	4	5	6
A	14.0	14.0	14.0	14.0	17.0	18.0
Shaft length mm	200	200	200	300	200	200
B						
Max. depth of enclosure with standard shaft (mm)	235	240	240	375	320	337

Note: 1) 'R' = Dimension represents the maximum width across mechanism spring guides.
 2) 'T' = Additional height of connecting barrier.
 3) First auxiliary pack adds 24.5mm to side of the switch when attached. Each additional auxiliary pack adds a further 10.5mm.

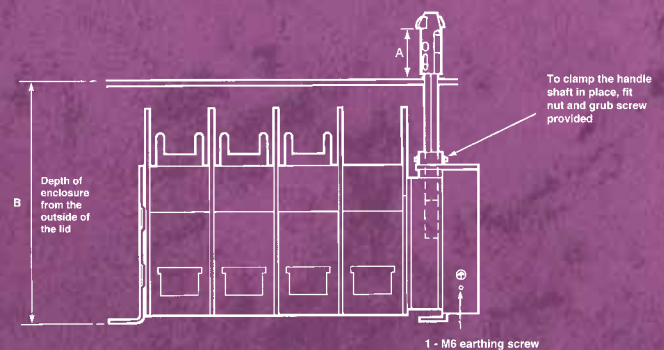

PANEL MOUNTING SWITCHGEAR

LBV SWITCH - DISCONNECTORS, 40-1600A, TP OR TPSN



SPECIFICATION

Each compact frame size, up to 1600A, is enclosed in a moulded, insulated housing which provides protection against the ingress of dust and foreign bodies. This housing also supports the fixed contact assembly ensuring that each contact is isolated from the operating mechanism when in the 'OFF' position. Visual indication of contact separation is provided.

Efficient operation and extended contact life results from the switch operating mechanism and the clip and blade wiping action, fixed and moving contact design.

The fixed contacts form part of the incoming and outgoing terminals which are of the box clamp type up to 63A and tinned copper lugs from 125 to 1600A ratings.

The moving contact assembly rigidly supports each pair of moving contacts and ensures simultaneous action of each contact pair during switching operations. Each moving contact pair consists of two silver plated copper contacts, spring assisted to ensure efficient contact. This spring assistance also compensates for repulsion stresses developed under normal operating conditions or when the switch is subject to high electro-dynamic forces. Each pole houses separate arc shutes to ensure arc extinguishment during operation.

Manually independent operating mechanisms are of the "stored energy" type. Operation of the handle loads the mechanism up to a point that the stored energy in the spring system is sufficient to change the position of the moving contact train ensuring quick make and break operation.

HANDLES AND 'ON-OFF' POSITION INDICATION

Black moulded handles (IP54) and operating shafts are supplied with each switch for door mounting. Handles may be padlocked in the 'OFF' position and incorporate a door interlocking facility which may be defeated by a competent, authorised operator.

'ON-OFF' position indication is threefold being shown on the operating handle base, the switch housing and, via a window in the switch housing, on the moving contact assembly.

APPLICATIONS

The LBV range of switches is suitable for AC operation up to 690V single phase or three phase.

DC operation up to 250V ($\frac{t}{R} = 15\text{ms max}$) may be achieved by series connection of three pole devices as shown in table 6.

SWITCH RATINGS

The load break switch range has been tested to the following specifications: BSEN60947-3 & IEC60947-3.

TECHNICAL INFORMATION

Table 1

RATED THERMAL CURRENT I _{th} (AC21)	A	40	63	125	160	250	400	630	1000	1600
Insulation Voltage	V	690	690	800	800	1000	1000	1000	1000	1000
Operating Voltage	Vac	690	690	690	690	690	690	690	690	690
	Vdc	-	-	440	440	440	440	440	440	440
Breaking Capacity AC23 415V cos $\theta=0.35$	A	320	504	1000	1232	2000	2440	4944	5520	10000
Breaking Capacity AC3 415V cos $\theta=0.35$	A	-	-	-	-	-	-	-	-	-
Making Capacity AC23 415V cos $\theta=0.35$	A	400	630	1250	1540	2500	3050	6180	6900	12500
Making Capacity AC3 415V cos $\theta=0.35$	A	-	-	-	-	-	-	-	-	-
Short time rating	kA	756	756	8	8	10	12	36	36	50
	sec	0.75	0.75	0.2	0.2	0.2	0.3	0.3	0.3	1
Short circuit making capacity 415V (peak)	kA	13	13	15.5	15.5	33	33	65	65	
Rated fused short circuit current 415V RMS	kA	100	100	100	100	100	100	100	100	110

Table 2

Rated operational current AC21: Resistive loads including moderate overloads.

NOMINAL RATING	A	40	63	125	160	250	400	630	1000	1600
at 380/415V	A	40	63	125	160	250	400	630*	1000*	1600
at 500V	A	40	63	125	160	250	400	630*	1000*	1600
at 690V	A	40	63	125	125	250	400	630*	1000*	1600

*switching category B according to IEC947

Table 3

Rated operational current AC22

NOMINAL RATING	A	40	63	125	160	250	400	630	1000	1600
at 380/415V	A	40	63	125	160	250	400	630*	1000*	1600
at 500V	A	40	63	125	160	250	400	630*	1000*	1600
at 690V	A	40	63	125	125	250	315	630*	1000*	1600

*switching category B according to IEC947

Table 4

Rated operational current AC23 Loads generated by 3-phase motors or other highly inductive loads.

NOMINAL RATING	A	40	63	125	160	250	400	630	1000	1600
at 415V	A	40	63	105	154	250	305	618*	690*	1250
	kW	22	30	59	90	147	180	375*	425*	750
at 500V	A	40	63	106	106	250	254	575*	575*	850
	kW	25	40	75	75	160	180	425*	425*	630
at 690V	A	40	63	-	-	138	138	437*	437*	630
	kW	37	59	-	-	132	132	425*	425*	630

*switching category B according to IEC947

Table 5

NOMINAL RATING	A	40	63	125	160	250	400	630	1000	1600
at 220/240V	A	40	63	105	160	250	305	618*	690*	1250
	kW	15	18	30	48	54	106	152*	245*	305
at 415V	A	40	55	80	125	150	300	460*	650*	800
	kW	22	30	45	75	85	165	225*	370*	455
at 550V	A	30	40	60	100	125	250	370*	540*	670
	kW	20	26	40	65	75	170	253*	320*	455

*switching category B according to IEC947

Table 6

Direct Current: Resistive or moderate loads. Four pole switches.

NOMINAL RATING	A	40	63	125	160	250	400	630	1000	1600
at 250V	A	-	-	125	125	200	315	500	800	-



PANEL MOUNTING SWITCHGEAR

LBV SWITCH - DISCONNECTORS, 40-1600A, TP OR TPSN

SWITCH DISCONNECTORS

NOMINAL RATING, I _e	LIST NUMBERS INCORPORATING DOOR MOUNTING, INTERLOCKING OPERATING HANDLE AND SHAFT.	
	TP LIST NUMBER	TPSN LIST NUMBER
	40A	34LBV
63A	36LBV	46LBV
125A	312LBV	412LBV
160A	316LBV	416LBV
250A	325LBV	425LBV
400A	340LBV	440LBV
630A	363LBV	463LBV
1000A	3100LBV	4100LBV
1600A	3160LBV	4160LBV

AUXILIARY CONTACTS

Auxiliary (micro-switch) contacts may be attached to the switch housing for use as:

- Signal contacts
- An early break device for tripping of remote contactor for off load switching.

DESCRIPTION	LIST NUMBER
1 c/o	1LBAXD
2 c/o	2LBAXD

TERMINAL SHIELDS

Transparent terminal shields are available for TP and TPN switches in sets of two suitable for screw fixing to the switch housing.

Each shield protects two terminals.

Switches rated up to 63A have finger protected terminals.

SWITCH RATING, A	LIST NUMBER
125 - 160	412TSD
250 / 400	440TSD
630	463TSD
630 / 1000	4100TSD
1600	4160TSD

SAFETY HANDLES

Red/yellow safety handles (IP54) suitable for up to three padlocks in the off position.

SWITCH RATING, A	LIST NUMBER
40 - 63	2SHNE
125	3SHNE
160 - 250	4SHNE
400 - 630	5SHNE
1000 - 1600	6SHNE

HANDLE SHAFTS

Standard length shafts are supplied with each switch, shafts of extra length can be supplied to order.

SWITCH RATING, I _e	SHAFT LENGTH (mm)		
	STANDARD SHAFT	NON STANDARD SHAFT	NON STANDARD SHAFT LIST NUMBER
20 - 63A	130	250	63LXSD
125 - 160A	130	250	160LXSD
250 - 400A	130	250	400LXSD
630 - 1000A	130	250	1000LXSD
1600A	130	200	1600LXSD

DIMENSIONS

(NOTE: Operating shafts shown in 'on' position to show dimension for handle engagement)

40 & 63A

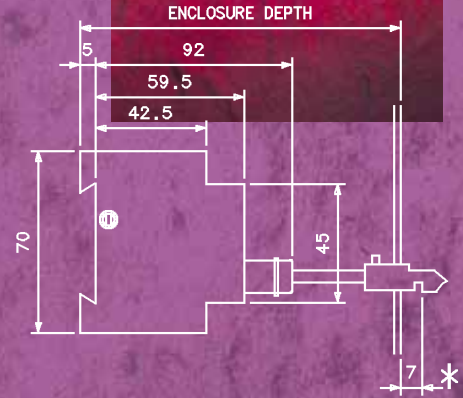
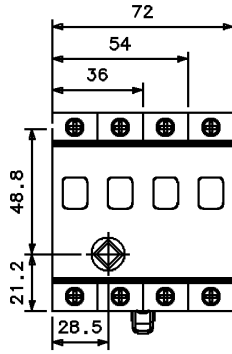

125A & 160A

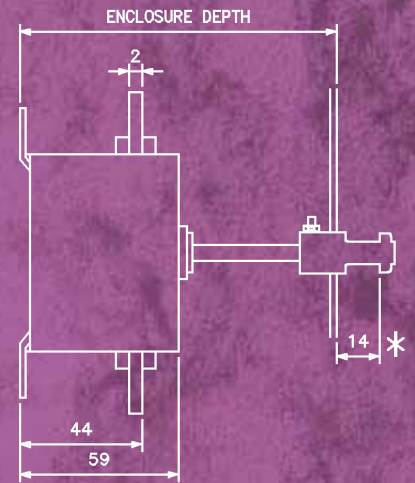
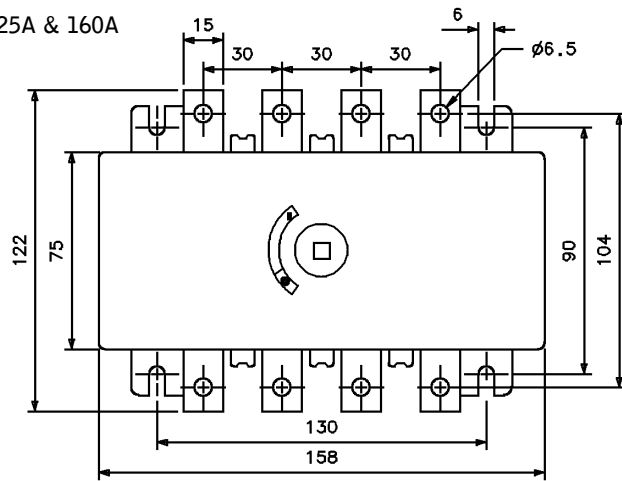

250A - 1000A

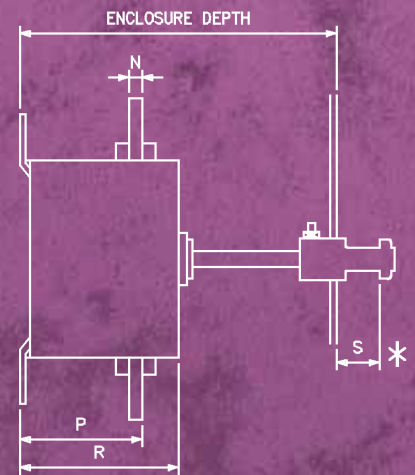
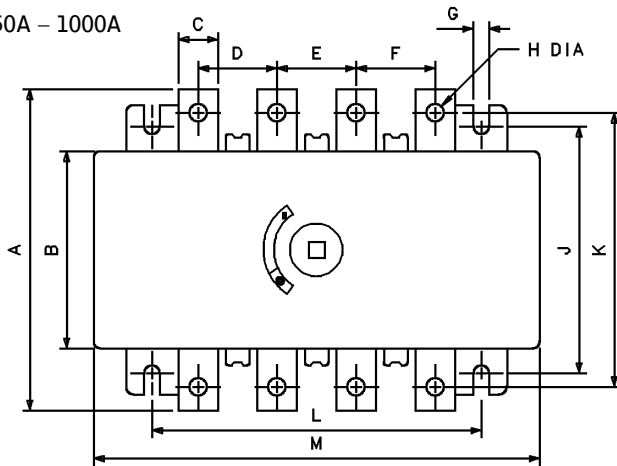

RATING	A	B	C	D	E	F	G	H DIA	J	K	L	M	N	P	R	S
250A	135	90	20	45	45	45	7	9	110	115	170	205	3	47	63	14
400A	146	90	25	45	45	45	7	11	110	122	170	205	3	47	63	14
630A	192	130	30	65	65	65	7	11	145	162	240	292	6	71	96	17
1000A	205	130	35	65	65	65	7	14	145	170	240	292	6	71	96	17

PANEL MOUNTING SWITCHGEAR

LBV SWITCH - DISCONNECTORS, 40-1600A, TP OR TPSN

1600A

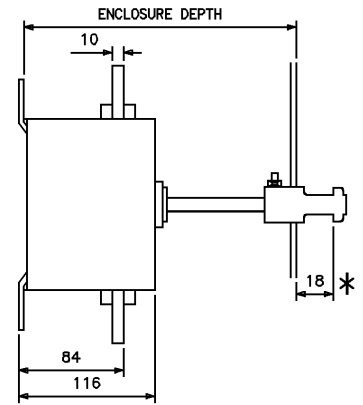
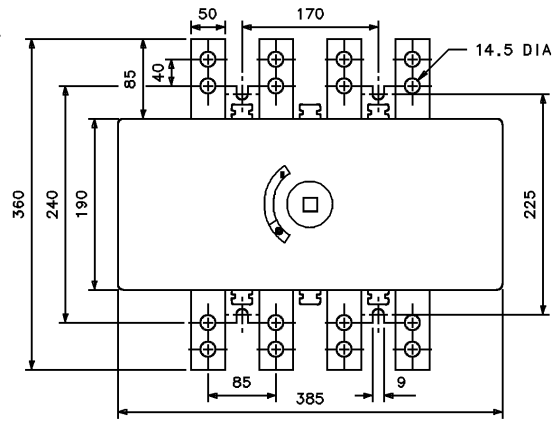

* NB: Operating shafts shown in 'ON' position to show dimension for handle engagement.

TERMINATIONS

Terminals for ratings up to 63A are of the cable clamping type and maximum size cable is 25mm². All other ratings are designed to accept solid copper or cable lugs. Stud sizes as table.

RATING A	40-63	125-160	250	400-630	1000	1600
Stud Size	-	M6	M8	M10	M12	2 x M12
Torque setting NM	2Nm	7Nm	14Nm	28Nm	40Nm	40Nm

HANDLE FITTING

40 – 63A

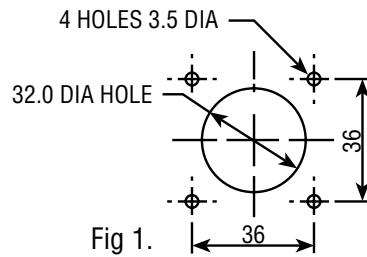

125 – 400A

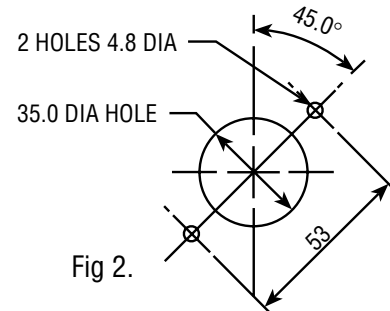

630 – 1000A

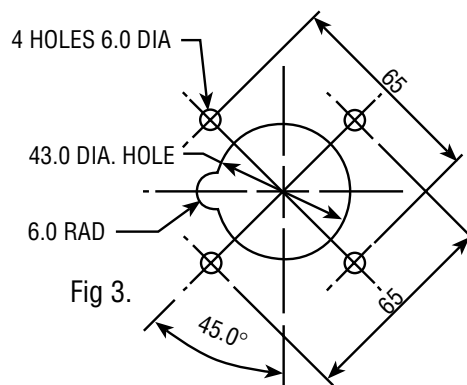

1600A

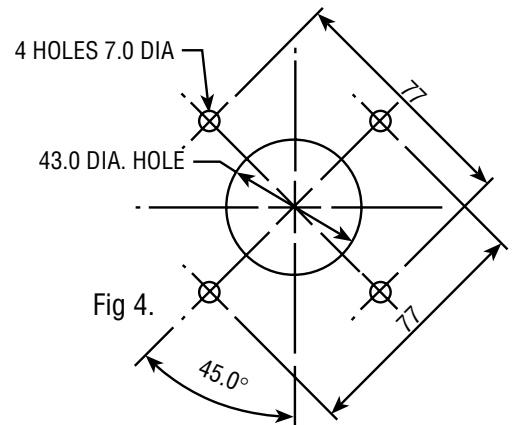

DIMENSIONS

Handle Aligned Thus:

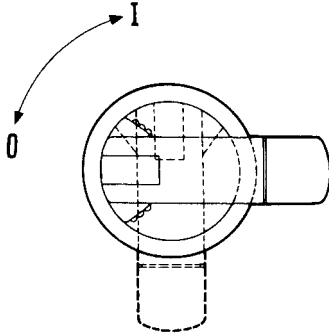

Handle Dimensions (mm)

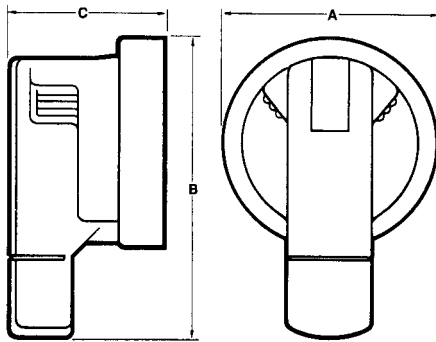

RATING	A	B	C
40 - 63	50	48	49
125	67	96.5	48
160 - 250	67	159.5	48
400 - 630	76	245	52.4
1000 - 1600	90	260/365*	58.9

*Extended Length

SPECIALIST HEAVY DUTY SWITCHGEAR

LOCAL SWITCH-DISCONNECTORS STANDARD DUTY, TYPE RDMP, 20-63A, IP65, 2-8 POLES



Complying with BSEN60947 and IEC 408 the RDMP range of rotary cam switches are suitable for on load switching of general distribution a.c. power circuits and infrequent duty motor isolation.

Grey, moulded thermoplastic enclosures provide protection to IP65 making them suitable for most indoor and outdoor environmental conditions.

These compact isolators are fitted with red/yellow operating handles padlockable in the 'OFF' position with up to three padlocks.

Units supplied with an early break auxiliary contact are indicated by a figure 1 in the list number e.g. 2021RDMP.

The enclosure design allows easy access for cabling. Solid neutral and earth termination points are a standard feature.

TECHNICAL DATA

NOMINAL UNIT RATING I _e	OPERATIONAL CURRENT, I _e AND POWER, 415V CATEGORY:		OPERATIONAL CURRENT, I _e AND POWER, 660V CATEGORY:		RATED SHORT TIME WITHSTAND CURRENT RMS FOR 1 SEC I _{cw}	RATED CONDITIONAL SHORT CIRCUIT CURRENT (PROSPECTIVE R.M.S. AMPS AT 415V AC, FUSED)		MAX TERMINAL CAPACITY mm ²	DEGREE OF PROTECTION
	AC21	AC23	AC21	AC23		kA	FUSE RATING		
20A	20A	5.5kW	20A	5.5kW	0.25kA	25	20A	1 x 4mm ² 2 x 2.5mm ²	IP65
25A	25A	7.5kW	25A	7.5kW	0.40kA	25	25A	1 x 6mm ² 2 x 4mm ²	IP65
40A	40A	15kW	40A	15kW	0.80kA	62	40A	1 x 10mm ² 2 x 6mm ²	IP65
63A	63A	22kW	63A	18.5kW	1.70kA	50	63A	1 x 16mm ² 2 x 10mm ²	IP65

Auxiliary contact rating as main poles.

ORDER REFERENCES

NOMINAL UNIT RATING, I _e	DOUBLE POLE AND NEUTRAL LIST NO.	TRIPLE POLE AND NEUTRAL LIST NO.	FOUR POLE LIST NO.	FOUR POLE AND NEUTRAL LIST NO.	SIX POLE AND NEUTRAL LIST NO.	EIGHT POLE LIST NO.
20A	2021RDMP	2031RDMP	204RDMP	2041RDMP	2061RDMP	-
25A	2521RDMP	2531RDMP	254RDMP	2541RDMP	2561RDMP	258RDMP
40A	4021RDMP	4031RDMP	404RDMP	4041RDMP	4061RDMP	-
63A	6321RDMP	6331RDMP	634RDMP	6341RDMP	6361RDMP	638RDMP

NB:- Switches with additional poles are available on request.

DIMENSIONS (MM)

NOMINAL UNIT RATING, I _e	A	B	C 2-4 POLE 20 & 40A 2-3 POLE 25 & 63A	C 6 POLE 20 & 40A 4-6 POLE 25 & 63A	D	E	F	G	H	R ISO THREAD
20 and 25A	90	90	71	98	30	79	63	30	4.5	2 x 20
40 and 63A	176	125	85	119	36	146	112	68	5.5	2 x 25 1 x 16

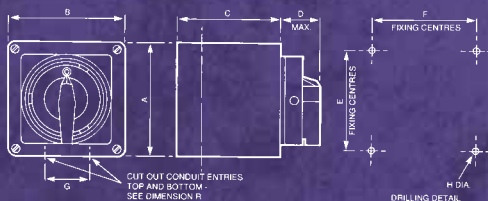

LOCAL SWITCH-DISCONNECTORS STANDARD DUTY, TYPE PC2, IP55, 2-6 POLES

Complying with BSEN60947 and IEC 408 the PC2 range of rotary cam isolating switches are suitable for on load switching of general distribution A.C. power circuits and infrequent duty motor isolation.

Grey, pressed steel enclosures provide protection to IP55.

These compact disconnectors are fitted with black operating handles, padlockable in the 'OFF' position.

The enclosure design allows easy access for cabling by removal of the switch interior.

Switches with additional poles are available on request.

2 pole and 4 pole units have removable neutral links included for SPN (from 2P) or TPN (from 4P) conversions.

Earth terminals provided as standard.



TECHNICAL DATA

NOMINAL UNIT RATING I _e	OPERATIONAL CURRENT, I _e AND POWER, 415V 3ph CATEGORY:		OPERATIONAL CURRENT, I _e AND POWER, 660V 3ph CATEGORY:		RATED SHORT TIME WITHSTAND CURRENT RMS FOR 1 SEC	RATED CONDITIONAL SHORT CIRCUIT CURRENT (PROSPECTIVE R.M.S. AMPS AT 415V AC, FUSED)		MAX TERMINAL CAPACITY	DEGREE OF PROTECTION
	AC21	AC23	AC21	AC23		kA	FUSE RATING		
20A	20A	5.5kW	20A	5.5kW	0.25kA	25 50	20A 16A	1 x 4mm ² 2 x 2.5mm ²	IP55
25A	25A	7.5kW	25A	7.5kW	0.40kA	25 50	25A 20A	1 x 6mm ² 2 x 4mm ²	IP55
40A	40A	15kW	40A	15kW	0.80kA	62	40A	1 x 10mm ² 2 x 6mm ²	IP55
63A	63A	22kW	63A	18.5kW	1.70kA	50	63A	1 x 16mm ² 2 x 10mm ²	IP55

ORDER REFERENCES

NOMINAL UNIT RATING, I _e	DOUBLE POLE LIST NO.	TRIPLE POLE LIST NO.	FOUR POLE LIST NO.	SIX POLE LIST NO.
20A	PC2G20 2	PC2G20 3	PC2G20 4	PC2G20 6
25A	PC2G25 2	PC2G25 3	PC2G25 4	PC2G25 6
40A	PC2G40 2	PC2G40 3	PC2G40 4	PC2G40 6
63A	PC2G63 2	PC2G63 3	PC2G63 4	PC2G63 6

DIMENSIONS

PC2G20,
PC2G25,
PC2G40
(2P-6P)

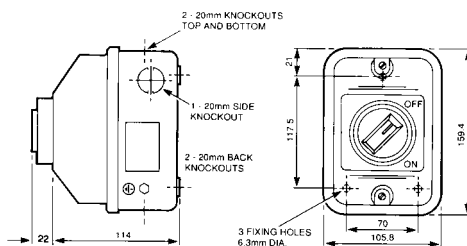

PC2G63,
(2P-6P)

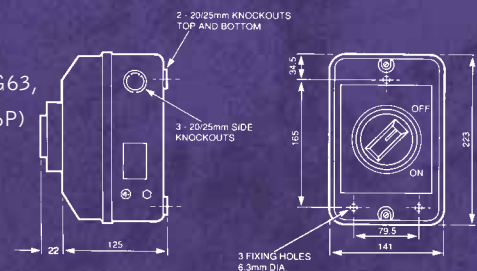

SPECIALIST HEAVY DUTY SWITCHGEAR

EXEL IP LOCAL SWITCH – DISCONNECTORS HEAVY DUTY, IP55, 20-1250A, 3-6 POLES



The IP55 range complies with BSEN60947. It consists of switches mounted in sheet steel enclosures, rust protected and having a powder coat finish.

All enclosures have bolt-on removable front covers with gland plates top and bottom. Cable entries must be site drilled. Switches are base mounted on the enclosure back plate.

Each enclosure has ample wiring space making additional cable boxes unnecessary when using standard copper cable.

Two tone grey operating handles are suitable for padlocking.

The range of disconnectors may be installed indoors or outdoors under sheltered conditions. They are ideally suited to installations where vibration or mechanical shock conditions prevail.

A variety of contact configurations and additional features are available – contact the factory for details.

EXEL IP LOCAL SWITCH – DISCONNECTORS HEAVY DUTY, IP65, 20-1250A, 3-6 POLES



The IP65 range complies with BSEN60947. This range has been designed specifically for outside locations where extremely adverse conditions exist.

Each switch is mounted in a weatherproof enclosure with a sealed switch spindle and lid mounted handle providing interlocking facility allowing the lid to be removed only when the switch is in the 'OFF' position.

The enclosure is toughly constructed of sheet steel with a durable, corrosion resistant coating of 70 microns (minimum) polyester powder coat providing a degree of protection of IP65.

Switches are supplied with - gland plates fitted to all units. Suitable weatherproof glands should be used during installation and cabling.

Operating handles have facility for padlocking in both 'ON' and 'OFF' positions.

The standard range is available in configurations of up to six main poles up to 160A and 3 or 4 pole for higher ratings.

TECHNICAL DATA IP55 & IP65 UNITS

NOMINAL UNIT RATING I _e	OPERATIONAL CURRENT, I _e AND POWER, 415V CATEGORY:			OPERATIONAL CURRENT, I _e AND POWER, 690V CATEGORY:		
	AC22	AC23	AC23	AC22	AC23	AC23
20A	20A	11kW	21A	20A	18.5kW	21A
40A	40A	22kW	40A	40A	30kW	40A
63A	63A	37kW	63A	63A	59kW	63A
125A	125A	59kW	125A	125A	-	-
160A	160A	90kW	154A	125A	-	-
250A	250A	147kW	249A	250A	129kW	134A
400A	400A	180kW	305A	315A	129kW	134A
630A	630A	375kW	630A	630A (B)	425kW	437A
1000A	1000A	425kW	690A	1000A (B)	425kW	437A
1250A	1250A	750kW	1250A	1250A	630kW	630A

NOMINAL UNIT RATING I _e	RATED SHORT TIME WITHSTAND CURRENT RMS FOR 1 SEC	SHORT CIRCUIT MAKING I _{t op}	RATED CONDITIONAL SHORT CIRCUIT CURRENT PROSPECTIVE RMS AMPS AT 415V AC, FUSED
			kA/FUSE RATING
20A	0.66kA	2.2kA	100kA/80A
40A	0.66kA	2.2kA	100kA/80A
63A	0.66kA	2.2kA	100kA/80A
125A	3.6kA	17.6kA	100kA/100A
160A	3.6kA	17.6kA	100kA/100A
250A	6.6kA	26.5kA	100kA/250A
400A	6.6kA	26.5kA	100kA/250A
630A	20.4kA	76kA	100kA/630A
1000A	20.4kA	76kA	100kA/630A
1250A	50kA	105kA	-

NOMINAL UNIT RATING I _e	RATED CONDITIONAL SHORT CIRCUIT CURRENT PROSPECTIVE RMS AMPS AT 690V AC, FUSED	MAX TERMINAL / CABLE SIZE	HOLE
	kA/FUSE RATING	MM ²	MM ²
20A	100kA/80A	25	-
40A	100kA/80A	25	-
63A	100kA/80A	25	-
125A	50kA/160A	15 wide x 2 thick	6.5
160A	50kA/160A	15 wide x 2 thick	6.5
250A	50kA/500A	20 wide x 3 thick	9.0
400A	50kA/500A	25 wide x 3 thick	11.0
630A	50kA/1000A	30 wide x 6 thick	11.0
1000A	50kA/1000A	35 wide x 6 thick	14.0
1250A	-	50 wide x 10 thick	18.5

SPECIALIST HEAVY DUTY SWITCHGEAR

ORDER REFERENCES IP55

NOMINAL UNIT RATING, Ie	TRIPLE POLE LIST NO.	TRIPLE POLE AND SOLID NEUTRAL LIST NO.	FOUR POLE LIST NO.	SIX POLE LIST NO.
20A	DE552031	DE55203N	DE552041	DE552061
40A	DE554031	DE55403N	DE554041	DE554061
63A	DE556331	DE55633N	DE556341	DE556361
125A	DE5512531	DE551253N	DE5512541	DE5512561
160A	DE5516031	DE551603N	DE5516041	DE5516061
250A	DE5525031	DE552503N	DE5525041	-
400A	DE5540031	DE554003N	DE5540041	-
630A	DE5563031	DE556303N	DE5563041	-
1000A	DE55100031	DE5510003N	DE55100041	-
1250A	DE55125031	DE5512503N	DE55125041	-

ORDER REFERENCES IP65

NOMINAL UNIT RATING, Ie	TRIPLE POLE LIST NO.	TRIPLE POLE AND SOLID NEUTRAL LIST NO.	FOUR POLE LIST NO.	SIX POLE LIST NO.
20A	DE652031	DE65203N	DE652041	DE652061
40A	DE654031	DE65403N	DE654041	DE654061
63A	DE656331	DE65633N	DE656341	DE656361
125A	DE6512531	DE651253N	DE6512541	DE6512561
160A	DE6516031	DE651603N	DE6516041	DE6516061
250A	DE6525031	DE652503N	DE6525041	-
400A	DE6540031	DE654003N	DE6540041	-
630A	DE6563031	DE656303N	DE6563041	-
1000A	DE65100031	DE6510003N	DE65100041	-
1250A	DE65125031	DE6512503N	DE65125041	-

DIMENSIONS (MM)

NOMINAL UNIT RATING, Ie	A (MM)	B (MM)	C (MM)	D (MM)	E (MM)
20A / 40A / 63A	225	245	131	150	170
20A / 40A / 63A 6 POLE	225	245	131	150	170
125A / 160A	325	325	131	250	250
125A / 160A 6 POLE	405	325	147	330	250
250A	385	705	136	310	630
400A	385	705	136	310	630
630A	505	1105	183	430	1030
1000A	505	1105	183	430	1030
1250A	505	1105	183	430	1030

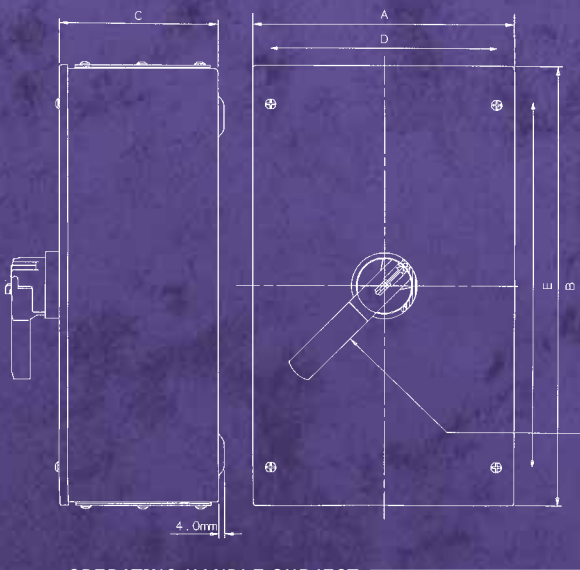

OPERATING HANDLE SUBJECT TO VARIATIONS

SPECIAL DISTRIBUTION & CONTROL EQUIPMENT SPECIALS WITH A DIFFERENCE

Our comprehensive range of circuit protection and control equipment, utilising the very latest technology, enables us to provide the solution to almost any installation problem.

Eaton MEM factory built assemblies are designed and manufactured specifically for customer's precise needs.

Special distribution and control equipment can be designed to incorporate, either individually or in a combination, a variety of fused equipment, MCBs, MCCBs, motor control gear and associated equipment. Comprehensive earth leakage protection and metering facilities can easily be incorporated. Special distribution systems can be built in to either a standard enclosure or, if required, within a larger enclosure with high specification environmental protection.



MEM

MEMFORM FORM 4 CUBICLE SWITCHBOARDS



- Form 4 individual metal compartments as standard
- Complies fully with BSEN60 439-1 and IEC60439-1
- Busbar ratings from 1000A to 10000A
- Naturally ventilated
- Totally enclosed busbars, risers and inter-connections in sheet steel compartments
- IP31 as standard
- Compact modular design to conserve space
- Front or rear access, with protective devices removable from the front
- Vertical/horizontal busbars are ASTA/KEMA Certified for short circuit performance:
 - 1000A - 50kA for 1 second
 - 1250A - 4000A - 50kA for 3 seconds
 - 1600A - 4000A - 80kA for 1 second
 - 2000A - 10000A - 100kA for 1 second
- Switchboards can incorporate: ACBs, MCCBs, fuse-switches, contactors, fuseboards, MCB boards and other ancillary equipment to customer specifications
- A full range of integral power factor correction equipment, TVSS and controls
- Wide range of control options includes PLC's and BMS interfacing
- A comprehensive range of metering
- Locking options include Castell/Fortress door, shaft and handle locking
- Versatile enclosure system allows for future extension of switchboard

Cubicle switchboards are of standardised modular construction giving a great degree of flexibility and good technical performance with cost effectiveness.

Eaton MEM specialises in producing equipment to the customer's precise needs. Thus metering, locking devices, power factor correction equipment, alternative paint finishes or other non-standard requirements may be specified.

Designed on a modular concept the Memform switchboard can be modified or extended in an infinite variety of ways with standard components - a factor which greatly reduces delivery times.

Both the front and rear access designs are fully cable segregated and suitable for top and bottom cable entry - with busduct and removable cable entry plates being provided where appropriate.

Cabling operations are simplified by the provision, as standard, of removable crossrails etc., thus enabling the 'laying-in' of cable tails. Cable gland location within the fully segregated wiring chamber is readily adjustable on site, both vertically and fore-and-aft, to suit specific requirements.

Combinations of the following earthing facilities are available:

- A FULL WIDTH EARTH BAR
- B GLAND RAIL/GLAND PLATE BONDING
- C SUPPLEMENTARY INTERNAL BONDING
- D STAR POINT EARTH/NEUTRAL LINK

REAR ACCESS SWITCHBOARDS

A unit generally more suited to heavy current applications which provides unobstructed access at the rear for cabling and both front and rear access for maintenance.

FRONT ACCESS SWITCHBOARDS

Designed for those applications where depth rather than length is a critical factor in the switchroom. This unit can be installed directly against a wall and is wholly accessible from the front for cabling and maintenance.



CUBICLE CONSTRUCTION

The Memform Form 4 system is designed so that combinations of fuse-switches, MCCBs, ACBs, MCBs, contactors, fuseboard assemblies, power factor correction, CTs, anti-condensation heaters and other ancillary equipment can be arranged in vertical stacks, complete with busbars, risers and interconnections - all enclosed with separation of the busbar system from functional units, and separation of all functional units from one another. Incoming and outgoing terminals are also separated from the busbars and from each other.

A complete switchboard layout can be quickly and easily determined for combinations of fuse-switches and/or moulded case circuit breakers.

Standard switchboard dimensions are shown below, however arrangements of switchboards can be accommodated to meet the customers own specifications.

The basic design includes corner sections for both Rear and Front Access types, providing facilities for 'L' or 'U' shaped assemblies.

COMPLIANCE WITH STANDARDS

The Memform Form 4 cubicle switchboard in its standard form complies fully with BSEN60439-1 and IEC60439-1.

STANDARD STACK DIMENSIONS (NOMINAL) FOR UP TO 80kA

FRONT ACCESS		REAR ACCESS	
Depth	600mm	Depth	1000mm
Height*	2000mm or 2300mm	Height*	2000mm or 2300mm

FOR 100kA

REAR ACCESS ONLY

Depth 1200 to 1800mm to meet system requirements

Height* 2300mm

*Not including ventilation cowls



- We can provide a complete system design and application service from our specialist technical team, based in Birmingham, who are always available to help and advise on any project.



MEMFORM FORM 4 CUBICLE SWITCHBOARDS



Choice of Protective Device

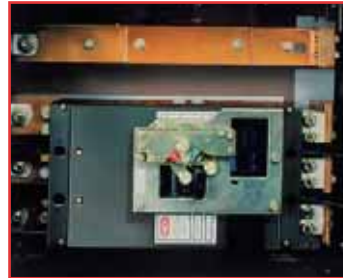

MCCB Rotary Handle Mechanism



Individual Circuit Monitoring



MCB Distribution Boards



HRC Fuse Distribution Boards



CT Arrangements



Castell, Handle and Shaft Locking

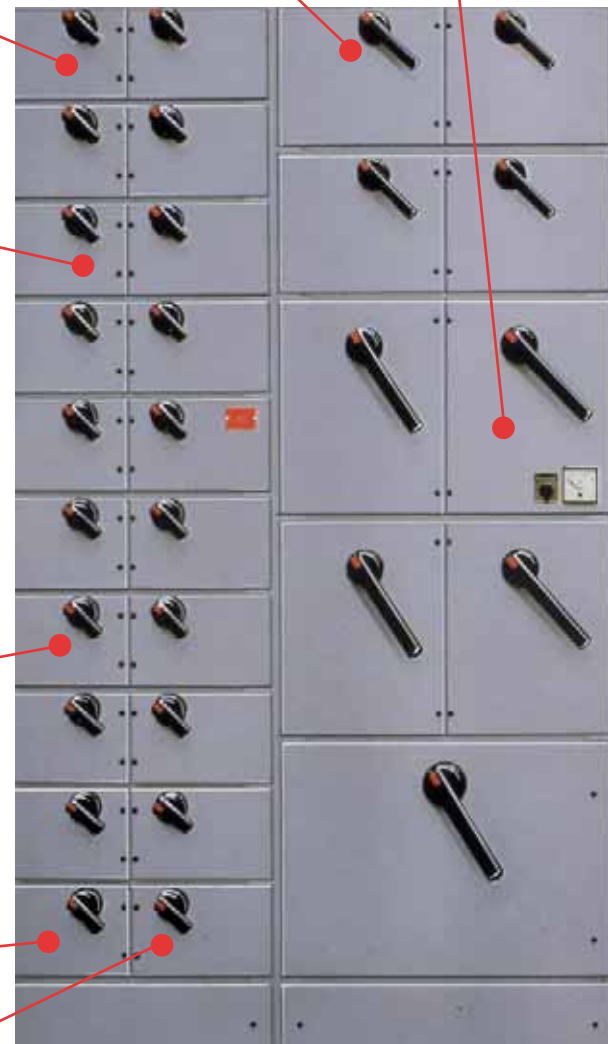



Power Factor Control



Contactors

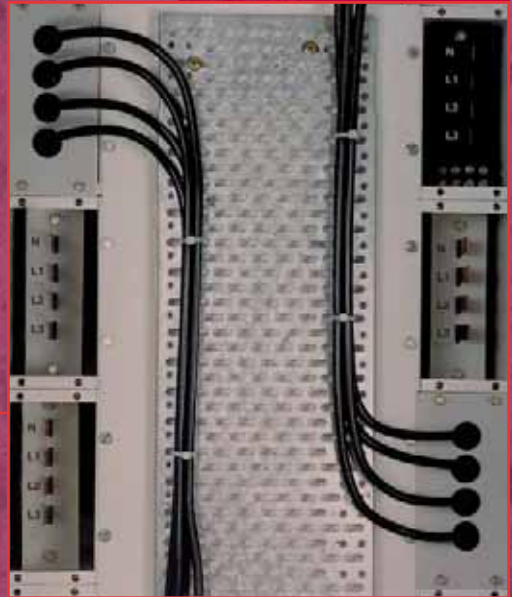

Contractor 'Friendly' Connections
Cable tray fitted as standard

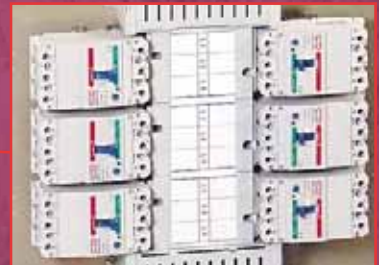
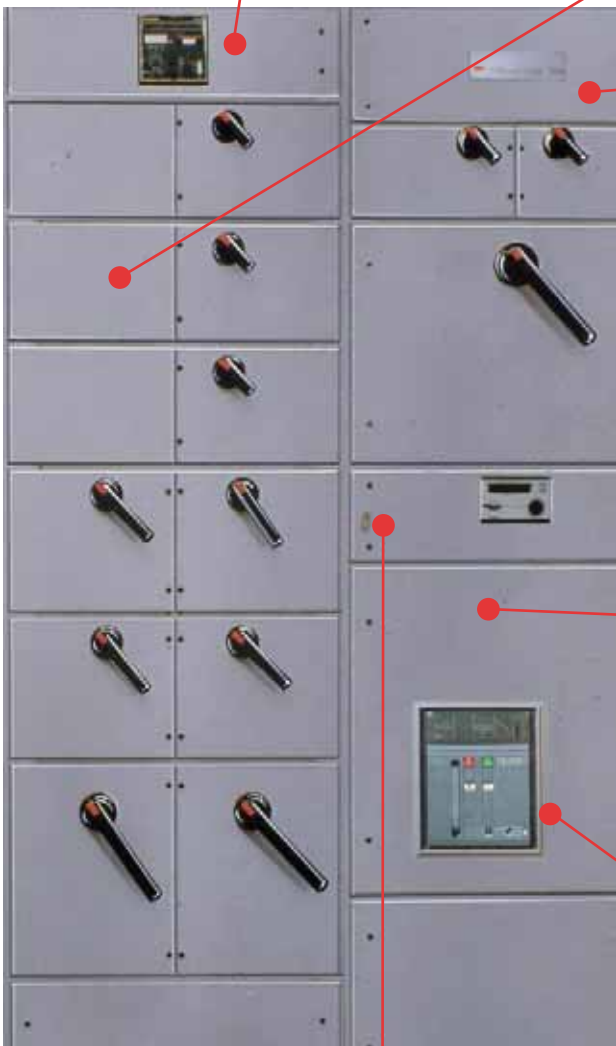

MCCB Distribution Boards



Typical Metering



Choice of Incoming Device



MEMFORM FORM 4 CUBICLE SWITCHBOARDS MEMFORM PACKAGED SUBSTATIONS



A typical indoor packaged substation comprises a power transformer to BS171 (IEC176) rated up to 4 MVA and a low voltage switchboard, assembled together to form a complete unit.

The transformer, generally of Class C air insulated design or resin encapsulated, is air cooled (AN) and housed in a ventilated sheet steel enclosure designed to match the front appearance of a MEMFORM Switchboard. Transformer ratings can be enhanced by the additions of fans and ratings up to 4MVA (AN) force cooled are available.

A fully supported copper busbar system connects between the transformer LV secondary terminals and the LV switchboard main incomer, which is usually an air circuit breaker.

Provision is generally made for MV cable termination into an appropriate cable box mounted at the rear or side of the transformer housing. It is possible however, to engineer the incoming MV circuit breaker, isolator or ring main unit (RMU) as part of a packaged substation installation.

A full inter-tripping facility between MV and LV circuit breakers as well as interlocking between transformer housing and MV breaker is available to meet specific requirements.

Standard forms of instrumentation, measuring and protective circuitry can be provided, the latter including alarm indication and trip relay protection for the transformer windings.

Impulse voltage requirements for the supply system can readily be met by the provision of surge diverters at the MV terminals of the transformer.

Due to the number of variations possible when putting together a composite package each substation is the subject of an individual design exercise, aimed at producing the optimum arrangement for the particular installation under consideration.

DEGREES OF PROTECTION, IP RATINGS

The degrees of protection against ingress of foreign bodies and liquids are indicated by the first two characteristic numerals as detailed in tables 1 and 2. For switch and control gear the classification is recognised internationally and is described in detail in BSEN60529.

FIRST NUMBER Protection against solid foreign objects IP	Requirements	Meaning protection of persons against access to hazardous parts with:
0	No protection.	non-protected
1	Full penetration of 50mm diameter sphere not allowed. Contact with hazardous parts not permitted.	back of hand
2	Full penetration of 12.5mm diameter sphere not allowed. The jointed test finger shall have adequate clearance from hazardous parts.	finger
3	The access probe of 2.5mm diameter shall not penetrate.	tool
4	The access probe of 1.0mm diameter shall not penetrate.	wire
5	Limited ingress of dust permitted (no harmful deposit).	wire
6	Totally protected against ingress of dust.	wire
SECOND NUMBER Protection against harmful ingress of water IP	Requirements	Meaning protection from water
0	No protection.	non-protected
1	Protected against vertically falling drops of water - limited ingress permitted.	vertically dripping
2	Protected against vertically falling drops of water with enclosure tilted 15° from the vertical - limited ingress permitted.	dripping up to 15° from the vertical
3	Protected against sprays to 60° from the vertical – limited ingress permitted.	limited spraying
4	Protected against water splashed from all directions – limited ingress permitted.	splashing from all directions
5	Protected against low pressure jets of water from all directions – limited ingress permitted.	hosing jets from all directions
6	Protected against strong jets of water – limited ingress permitted	strong hosing jets from all directions.
7	Protected against the effects of immersion between 15cm and 1m.	temporary immersion
8	Protected against long periods of immersion under pressure.	continuous immersion
ADDITIONAL LETTER (Optional) IP	Requirements	Meaning protection of persons against access to hazardous parts with:
A For use with 0	Penetration of 50mm diameter sphere up to guard face must not contact hazardous parts.	back of hand
B For use with 0 & 1	Test finger penetration to a maximum of 80mm must not contact hazardous parts.	finger
C For use with 1 & 2	Wire of 2.5mm diameter x 100mm long must not contact hazardous parts when spherical stop face is partially entered.	tool
D For use with 1, 2 & 3	Wire of 1.0mm diameter x 100mm long must not contact hazardous parts when spherical stop face is partially entered.	wire
		Limited penetration allowed with all four additional letters

I N D U S T R I A L S W I T C H A N D F U S E G E A R I N D E X

LIST NO.	PAGE	LIST NO.	PAGE	LIST NO.	PAGE
215, 230AF	18	DS100-00 - DS160FP-00	42	35 - 45LCS	29
220 AFF	18	DS250-1 - DS630FP-3	42	6, 8LD	4
2020, 2025AFEW	19	EBK105SP - 113SP	7	4, 5LD	14
AL1	16	EBS843SP	21	8, 9LD	21
1, 2 AP	19	3EN	19	2 - 32LS	30
405 - 759 APL	7	EP539/842	15	63 - 1600 LXSD	56
ASP	47	EP539 - 881	21	15 - 100MBA2	35
1ASP - 8ASP	47	80 - 100ESSCF	16	15 - 100MBB2	35
1ATS2 - 4	47	ETM2209 - 2226SP	21	100MBDEBSP	15
15 - 100AXD2	15	1FC2 - 6FC3	47	600, 1000MEB	19
2100 AXDEBSP	15	3FLD - 6FLD	47	20 - 200MFA	37
230 - 2100 AXEBSP	15	6 - 20 FMA	33	20 - 200MFB/W	37
15 - 125AXTN2	15	7 - 180 FNA	33	20 - 200MFC/W	37
142 - 846 BBC	11	2FNP	18	20 - 200MFD	37
2 - 6 BBCL	13	160 - 450 FPA	33	100 MFLK	22, 36, 37
21 - 81 BBL	12	400 - 900 FPA2	33	63, 100MFRCL	22, 37
11 - 61 BBMS	13	8 - 80 FRB	34	63 - 800 MLK	5, 37
31 - 61 BBPU	10	6 - 20 FSB	34	MP202 - MP633N	16
62 - 82 BBSK	13	200 - 800 FSCS	13	3MP - 6MP	47
10 BM/D/L	12	65 - 160 FTB2	34	N1FC2 - N1FC3	47
32 CBB/W	37	160 - 355 FUB	34	15 - 100MRH2	35
32, 63CFB/W	37	180 - 710 FUB2	34	NH0125 - 03630	31
32, 63CFF/W	37	102 - 402GCEBSP	7	NHC006 - 00100	31
32, 63CLK	37	61 - 803GNC	5	NHH	31
1 CLX	21	64 - 804GC	5	0BK103SP	7
100 CMFA - 315 CMFDW	37	63 - 803GNL	5	0LV725SP - 728SP	15
50 - 90 CSB/A	6	IS452 - IS10004	41	1 - 6PCB	6
CV1109SP	15	63 - 250JCF	32	PC2G20 2 - PC2G63 6	61
D1FC3 - D5FC4	47	63 - 400JCS82	32	PD1	4, 14, 21
D2TS3 - D5TS4	47	63 - 630JCS92	32	PD2	16
D3FC2 - D3FC3	47	KS00 - 03	31	PD4	14
D4FC3E - D4FC4E	47	15 - 100KXDC2F	15	3PLD - 6PLD	47
D4TS3E - D4TS4E	47	230, 260 KXEBS	15	154 - 1004R	29
432 - 4800 DA	17	15 - 100KXSC2F	15	204 - 6361RDMP	60
200 - 630DAM	18	15KXSC2FRED	15	304 - 1004RL	29
DE 552031 - 5516061	64	15 - 125KXTNC2F	15	32S332 - 800S3710	41
DE 652031 - 6516061	64	1 - 2 LBAXD	56	2 - 32SA2	25
2 - 32DR	30	34 - 4160LBV	56	2 - 20SA2-550	26
DS63-000 - DS63FP-000	42	5 - 3025LC	29	20SA2M25, 32	25

INDUSTRIAL SWITCH AND FUSE GEAR INDEX

LIST NO.	PAGE	LIST NO.	PAGE
32SA2M40, 50, 63	25	250, 315SG7-550	28
32S1N32 - 200S1N200	41	SH1539	21
32S3N32 - 800S3N710	41	SH265, 754SP	15
32S1SN32 - 200S1SN200	41	3SHN - 6SHN	47
32S3SN32 - 800S3SN710	41	355, 400SH8	27
2 - 32SB3	25	355, 400SH8-550	28
2 - 32SB3-550	26	450 - 630SH9	27
32 SB3M40, 50, 63	25	450 - 630SH9-550	28
35 - 63SB4	25	710, 800SH10	27
40 - 63SB4-550	26	710, 800SH10-550	28
63SB4M80, 100	25	2 - 6 SHNE	56
32SC332 - 400SC3400	42	1000, 1250SJ11	27
32SC3N32 - 400SC3N400	42	SMDS63-000 - SMDS63FP-000	43
32SC3SN32 - 400SC3SN400	42	SMDS100-00 - SMDS160FP-00	43
1 - 100 SCHF	35	32SM3N32 - 200SM3N160	41
32 - 100 SD5	25	32SM3SN32 - 200SM3SN160	41
80 - 100SD5-550	26	32SM332 - 200SM3160	41
100SD5M125 - 200	25	2 - 32SN2	29
125 - 200SD6	25	20SN2M25, 32	29
125 - 200SD6-550	26	32 SN2M50, 63	29
200SD6M250, 315	25	80 - 200SO	16, 25
2 - 32SE3	27	100SOM125, 160	25
40 - 63SE4	27	16 - 63SP	29
63SE4M80, 100	27	2 - 32SS	30
2 - 32SF3	27	32ST3N32 - 400ST3N400	42
63SF4M80,100	27	32ST3SN32 - 400ST3SN400	42
80, 100SF5	27	32ST332 - 400ST3400	42
80 - 100SF5-550	28	450 - 630 SY9	27
100SF5M125 - 200	27	710 - 800 SY10	27
125 - 200SF6	27	1TS4 - 6TS4	47
125 - 200SF6-550	28	32TS2 - TS4	47
200SF6M250, 315	27	412 - 4160TSD	56
250, 315SF7	27	WA1212	22
250, 315SF7-550	28	3XS - 6XS	47
315SF7M400	27	204 - 213XSNC	22
355, 400SF8	27	204 - 2006XTNC	22
400SF8M500	27		
355, 400SF8-550	28		
250, 315SG7	27		

UK MANUFACTURING

INDUSTRIAL SWITCHGEAR, CONTROL GEAR, CIRCUIT BREAKER SYSTEMS AND BUSBAR TRUNKING:

MEM Circuit Protection & Control
Reddings Lane,
Birmingham B11 3EZ
Tel: 0121 685 2100
Fax: 0121 706 2012
Busbar Trunking
Tel: 0121 707 9797
Fax: 0121 707 4840

TOTAL PROJECT MANAGEMENT, MV & LV SWITCHBOARDS, PFC & TVSS:

MEM Circuit Protection & Control
Premier Street, Birmingham B7 5TQ
Tel: 0121 326 2500
Fax: 0121 327 0656
Fax: Estimation: 0121 326 2541
Fax: Project Management:
0121 326 2567

ELECTRICAL ACCESSORIES AND DOMESTIC SWITCHGEAR:

MEM 250
Whitegate, Broadway,
Chadderton, Oldham,
Lancs. OL9 9QG
Tel: 0161 652 1111
Fax: 0161 626 1709

UK REGIONAL SALES OFFICES

South East Regional Sales Office
Suite 8
Ensign House
Admiral's Way
London E14 9XQ
Tel: 0207 987 8602
Fax: 0207 987 4632

South West, Midlands,
North & Scotland Sales Office
Reddings Lane
Tyseley
Birmingham B11 3EZ
Tel: 0121 685 2155
Fax: 0121 685 2191

INTERNATIONAL LOCATIONS

Eaton Electric Switchgear Sdn. Bhd
PO Box 162,
12720 Butterworth,
Seberang Perai, Malaysia
Tel: (60) 4 3907566
Fax: (60) 4 3990746

Bell - A Division of
Eaton Electric Systems Pty Ltd
10 Kent Road, Mascot,
NSW 2020, Australia
Tel: (61) 2 9693 9333
Fax: (61) 2 9693 1258

Eaton Electric Ltd
PO Box 30838, Dubai,
United Arab Emirates
Tel: (971) 4 2660187
Fax: (971) 4 2693774

Eaton Holec
PO Box 23,
7550 AA Hengelo
The Netherlands
Tel: (31) 74 246 9111
Fax: (31) 74 246 4444

Eaton Electric Switchgear (Asia
Pacific) Pte Ltd
50 Genting Lane #03-05,
Cideco Industrial Complex,
Singapore 349558
Tel: (65) 7410737
Fax: (65) 7410738

Eaton Electric Company Ltd
595 Pracha-Uthit Road,
(Ramkhamhaeng 39)
Wangthonglang Bangkok,
10310, Thailand
Tel: (66) 2 935 6470
Fax: (66) 2 935 6478

Eaton Electric Ltd
PO Box 1993
Doha, Qatar
Tel: (974) 4654792
Fax: (974) 4654792

Eaton Innovative Technology
15470 Flight Path Drive,
Brooksville,
Florida 34604, USA
Tel: 001 352 799 0713
Fax: 001 352 796 0316

Eaton Electric & Engineering
Services Ltd
6th Floor, Mtl Warehouse,
Phase 11 Berth One,
Kwai Chung Container Terminal
Kwai Chung, N.T. Hong Kong
Tel: (852) 2942 4388
Fax: (852) 2615 2289

Eaton Electric Ltd
East African Regional Office
1st Floor, Liaison House,
State House Avenue,
PO Box 48010,
Nairobi, Kenya
Tel: (254 2) 2719230/2718859
Fax: (254 2) 2711969

Eaton Elek
AM Alten Bach 18,
41470 Neuss,
Germany
Tel: (49) 21 37 7810
Fax: (49) 21 37 781152

MEM Circuit Protection & Control
Eaton Electric Limited
Reddings Lane
Birmingham B11 3EZ
Tel: 0121 685 2100
Fax: 0121 706 2012
Sales Support 0121-685 2000
Technical Support 0121-685 2001
Fax for Orders & Sales Enquiries 0121-706 9996
Central Quotation Service: 0121 326 2541
Email: meminfo@eaton.com
www.memonline.com

EATON

MEM